

MAGEWELL®



ULTRA ENCODE A10

User Manual, Reference and FAQ

TABLE OF CONTENTS

Preface	03	LCD Touchscreen	19
Introduction	03		
Key Features	04	Web UI Configuration	22
System Requirements	04	Access the Web UI	22
		Sign In/Out	24
Tutorial	05	Dashboard	25
Part 1. Ultra Encode Setup	05	Input	28
Part 2. YouTube Setup	09	Encode	37
		Live	43
Installation	10	Record	68
Safety Information	10	Overlay	83
FCC Compliance Statement	11	General	89
Interfaces & Indicators	12	Network	95
Installing the Encoder in a 1U Rack	14	User Admin	100
		Firmware	105
Get Started With Ultra Encode	15	Control Hub	106
Access Web UI	15	About	109
Initialization	18		
		FAQ	113

Preface



Introduction

Ultra Encode AIO offers systems integrators, streaming professionals, and OEM partners a flexible and affordable encoding solution for applications including live streaming, AV over IP, remote contribution, IP production workflows and much more. This device is ideal for high-quality live streaming of content including sports, education, and live events as well as IP-based production and AV-over-IP.

Encoder supports multiple video encoding formats – including H.264, H.265 (HEVC), NDI[®]|HX2, and NDI[®]|HX3 – and a wide array of delivery protocols including RTMP, RTMPS, SRT, RTSP, RTP, HLS, TS over UDP, TS over RTP, and TVU's ISSP technology. Up to eight channels of audio can be encoded in AAC format. What's more, scheduler for Twitch, YouTube and Facebook Live and other servers helps fix this problem by allowing you to schedule your streams directly from Web UI. It features easy-to-use controls where you can set up the day's streams in advance or reschedule them with just a few clicks. The recording function allows you to archive your encoded content to storage media, such as SD card, USB flash drive, NFS/CIFS server, etc., which is convenient for you to carry out follow-up work such as archiving and review.

Encoder is ideal for broadcast video and audio, natively support live broadcast for Facebook, YouTube, and Twitch, as well as your own site, with multi-platform distribution. To customize encoder perfectly for your session, we have Web UI, where device work status, a thumbnail preview window and tabs for streaming settings, analytics, and stream health monitoring are provided.

Key Features

- Support RTSP/RTMP/RTMPS/SRT Caller/SRT Listener/NDI®|HX2/NDI®|HX3/HLS/TS over UDP/TS over RTP/TVU ISSP streaming protocols
- Dual stream encoding - main-stream and sub-stream
- 8 overlays for main and sub streams each
- Specify main stream or sub stream for each streaming session
- Multi-streaming to various video platforms simultaneously and up to 8 schedules are supported for each session.
- H.264 and H.265 (HEVC) Video encoders
- Recording main or sub streams to SD card, USB drive, and NAS. Up to 8 schedules are supported for each task.
- AAC Audio encoder
- Web UI - a remote network management system - provides webpage configuration with kinds of customization for device functions

System Requirements

Network

- 10/100/1000Mbps Ethernet
- Wi-Fi 802.11 a/b/g/n/ac
- USB 4G/5G mobile broadband modem (not included)
- USB Net

Web UI Supported Web Browser

- Microsoft Edge
- Mozilla Firefox version 61 and above
- Google Chrome version 49 and above
- Apple Safari 11.1 and above
- Opera 55.0.2994.44 and above

Supported Product

- Ultra Encode AIO

Tutorial

Let's learn by example.

Throughout this tutorial, we'll walk you through the creation of a basic YouTube live streaming with Ultra Encode.

It'll consist of two parts:

[Part 1. Ultra Encode setup](#)

[Part 2. YouTube setup](#)

Part 1. Ultra Encode Setup

1. Find Ultra Encode

1. Connect the encoder to a LAN and power it up.
2. Connect input signal.
3. Access Web UI:
 - Tap on the LCD touch screen of the device front panel until you see a QR code, scan the QR code, or type the IP address below the QR code into your web browser.

Scanner (like smartphone) should be connected to the same local network as your device.

When the IP address shows 192.168.48.1, follow the steps below to join the device AP and access the Web UI.

- i. Plug included Wi-Fi antenna when you want to connect to a wireless network.
- ii. In your smartphone/tablet/laptop, turn on WLAN, search for and join the device AP named **Ultra Encode + (Serial number)**.
The AP names after your gear's **Serial number**, and the password is the last 8-number of the serial number by default. For example, a serial number 313210101001 indicates the initial AP password is 10101001.
We recommend that the distance between the Web UI and the encoder should be within 10m.
- iii. In your web browser, enter 192.168.48.1 to open the Web UI.

⚠ Tap on the LCD screen, you can find the Web UI QR code, record and live status, network connection status and so on.

- Log in with your username and password.



Scan the QR code

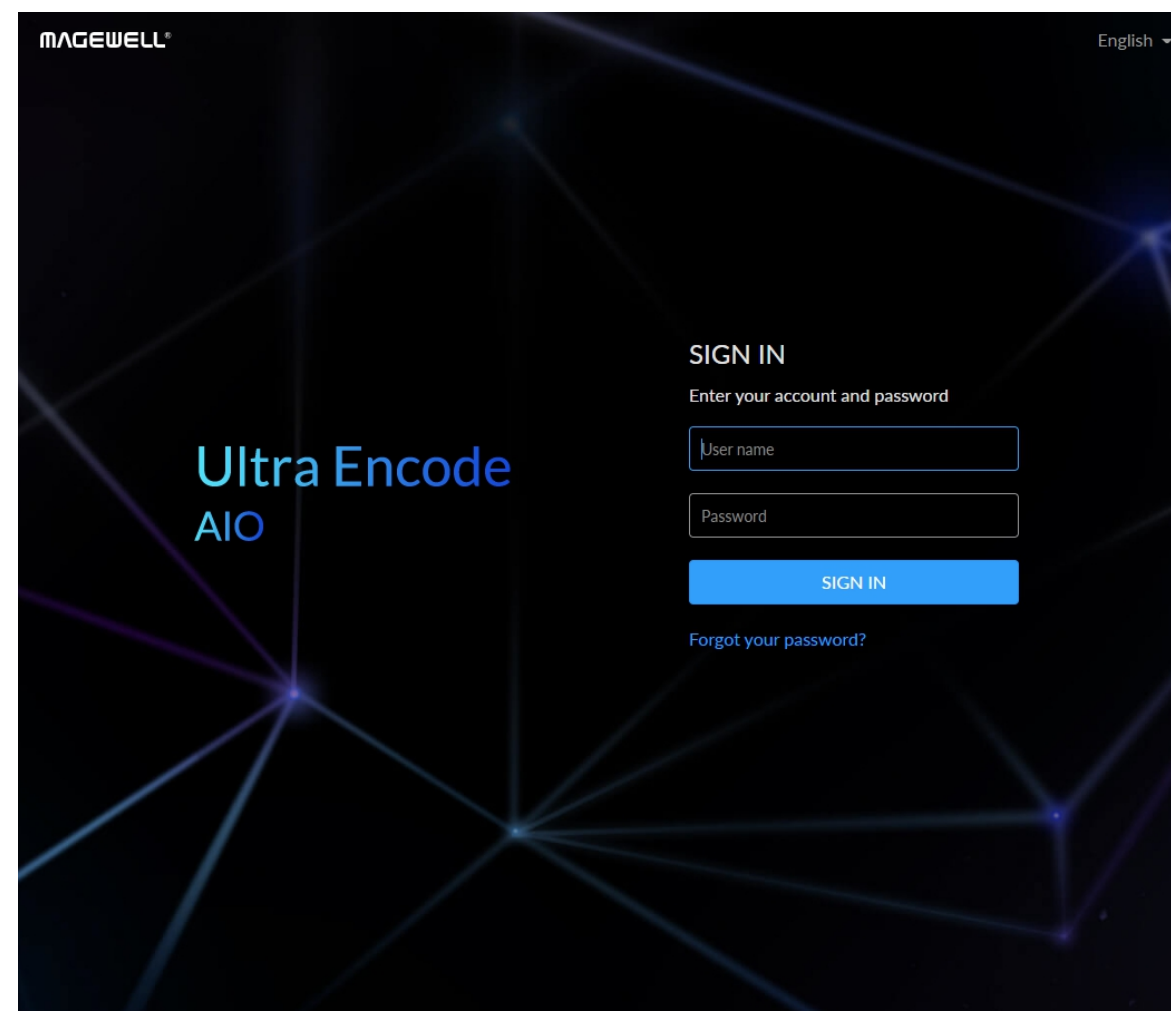

Sign In

2. Add YouTube streaming session

If you need low latency, then YouTube RTMP is the better option. However, if you need adaptive bitrate streaming, then YouTube HLS is the better option.

1. In the left control pane, go to **Live** tab. Click **Add Server** and choose YouTube RTMP or YouTube HLS.
2. Go to YouTube <https://www.google.com/device>, and paste the code prompted.

YouTube RTMP



Next, visit
<https://www.google.com/device> on
your smartphone or computer and
enter this code:

YQFG-TGWL

Go to YouTube



Connect a device

Enter the code displayed on your device

Enter code

YQFG-TGWL

Next

3. Follow the page instructions to log in and trust your device.

YouTube RTMP



Next, visit

<https://www.google.com/device> on
your smartphone or computer and
enter this code:

YQFG-TGWL

Go to YouTube

Sign in with Google



Choose an account

to continue to **Ultra Streamer**



Use another account

To continue, Google will share your name, email address, language preference, and profile picture with Ultra Streamer. Before using this app, you can review Ultra Streamer's [privacy policy](#) and terms of service.

4. Choose the **Event** where you want to show your video clips. Set whether your content is made for kids. Then you can simply save the server with default parameters for streaming.
5. Go back to the **Live** tab and turn on the switch before YouTube icon to start the streaming session. Now the encoder is ready to bring your content to YouTube directly with all these settings.

Part 2. YouTube Setup

Create a live stream task in YouTube Studio to go live, and specify the Title, Category, Privacy, etc.

The screenshot displays the YouTube Studio interface for configuring a live stream. The top navigation bar includes the YouTube logo, a menu icon, and user profile information. The main content area is divided into several sections:

- Stream Setup:** A central area with a camera icon and the text "Connect streaming software to go live" and "Viewers will be able to find your stream once you go live". A "STREAM SETUP HELP" link is provided.
- Stream Details:** A panel on the right showing:
 - Title: **Live Stream** (with an "EDIT" button)
 - Category: **Gaming** (with a sub-category "Game")
 - Privacy: **Private** (with a lock icon)
 - Viewers waiting: **0**
 - Likes: **0**
- Stream Settings:** A tabbed interface with three tabs: "STREAM SETTINGS", "ANALYTICS", and "STREAM HEALTH".
 - Stream key:** A dropdown menu set to "Default stream key (Variable)". Below it, a text field for the stream key (masked with dots) has "RESET" and "COPY" buttons.
 - Stream URL:** A text field containing "rtmp://" with a "COPY" button.
 - Backup server URL:** A text field containing "rtmp://" with a "COPY" button.
 - Stream latency:** Three radio button options: "Normal latency", "Low-latency" (selected), and "Ultra low-latency".
 - Additional settings:** A panel on the right with several toggle switches:
 - Enable DVR: **On**
 - 360° video: **Off**
 - Added delay: **None** (dropdown menu)
 - Closed captions: **Off**
 - Unlist live replay once stream ends: **Off**

On the right side of the interface, there is a "Live chat" section with a welcome message: "Welcome to live chat! Remember to guard your privacy and abide by our community guidelines." and a "LEARN MORE" link. At the bottom right, a chat input field is visible with the placeholder text "Say something..." and a character count "0/200".

Installation

Safety Information

Electrical Safety

- Seek professional assistance before using an adapter or extension cord. These devices could interrupt the grounding circuit.
- Make sure that you are using the correct power adapter for the local voltage. If you are not sure about the voltage of the electrical outlet you are using, contact your local power company.
- If the power adapter is broken, do not try to fix it by yourself. Contact a qualified service technician or your retailer for help.

Operation Safety

- Before using the product, make sure all cables are correctly connected and the power cables are not damaged. If you notice any damage, contact your dealer immediately.
- To avoid short circuits, keep paper clips, screws, and staples away from connectors, slots, sockets and circuitry.
- Avoid dust, humidity, and temperature extremes. Do not place the product in any area where it may become wet.
- If you encounter technical problems with the product, contact your dealer or the Magewell Support Team via support@magewell.net.

FCC Compliance Statement

This device complies with Part 15 of the FCC Rules. Operation is subject to the following two conditions:

- (1) this device may not cause harmful interference, and cause undesired operation
- (2) this device must accept any interference received, including interference that may cause undesired operation.

FCC Statement

This device has been tested and found to comply with the limits for a Class B digital device, pursuant to Part 15 of the FCC Rules. These limits are designed to provide reasonable protection against harmful interference in a residential installation. This device generates, uses and can radiate radio frequency energy and, if not installed and used in accordance with the instructions, may cause harmful interference to radio communications.

However, there is no guarantee that interference will not occur in a particular installation. If this device does cause harmful interference to radio or television reception, which can be determined by turning the device off and on, the user is encouraged to try to correct the interference by one or more of the following measures:

- Reorient or relocate the receiving antenna.
- Increase the separation between the device and receiver.
- Connect the device into an outlet on a circuit different from that to which the receiver is connected.
- Consult the dealer or an experienced radio/TV technician for help.

Changes or modifications not expressly approved by the party responsible for compliance could void the user's authority to operate the equipment.

FCC Radiation Exposure Statement

The antennas used for this transmitter must be installed to provide a separation distance of at least 20cm from all persons and must not be co-located for operating in conjunction with any other antenna or transmitter.

Interfaces & Indicators

Ultra Encode AIO

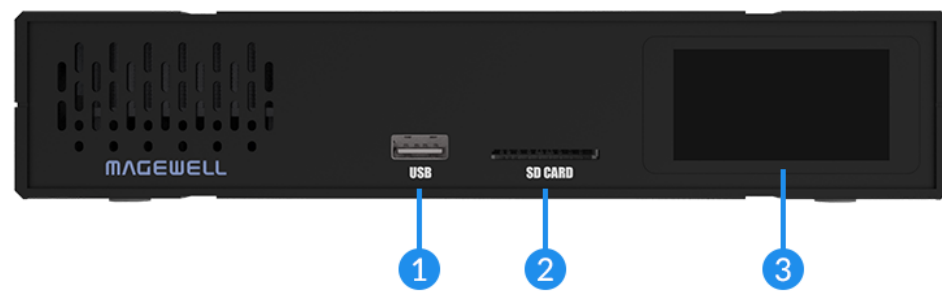

- ① USB-A
- ② SD card
- ③ LCD display
- ⑦ Ethernet/PoE+
- ⑧ HDMI IN/LOOP THRU
- ⑨ LED indicators

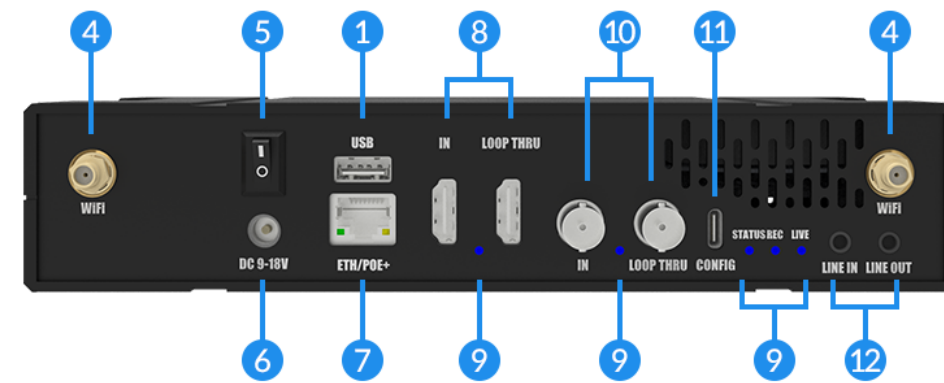

- ④ Wi-Fi antenna socket
- ⑤ Power switch
- ⑥ Power socket
- ⑩ SDI IN/LOOP THRU
- ⑪ USB-C
- ⑫ LINE IN/OUT

⚠ Plug included Wi-Fi antenna when you want to connect to a wireless network.

Indicators

Indicators status is as follows.

HDMI/SDI IN

- On: input signal detected.
- Breathing: input signal undetected.

STATUS

- On: The device has started and ready to work.
- Off: The Device cannot start.

REC

- On: the encoder is recording to at least one destination.
- Breathing: none of the rec sessions is enabled.

LIVE

- On: the encoder is streaming to at least one streaming address.
- Breathing: none of the live sessions is enabled.

The indicator lights flash in turn from HDMI IN, to Live : firmware is updating.

Installing the Encoder in a 1U Rack

Ultra Encode AIO provides substantial performance in a space-saving design. These encoders are easy to deploy and offer flexibility to expand later on.

You can install two devices side by side in a 1U rack with provided short rack ears and retainer plate, see [Fig1](#), or one device with provided long rack ears, see [Fig2](#).

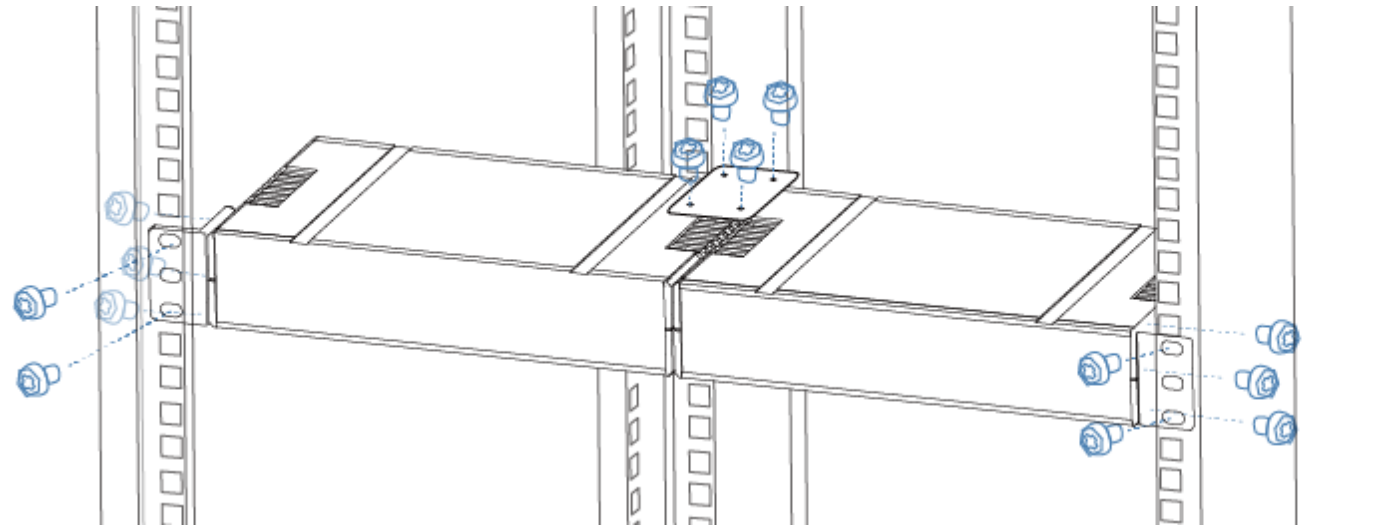

Fig1 Two units united installation with short rack ears

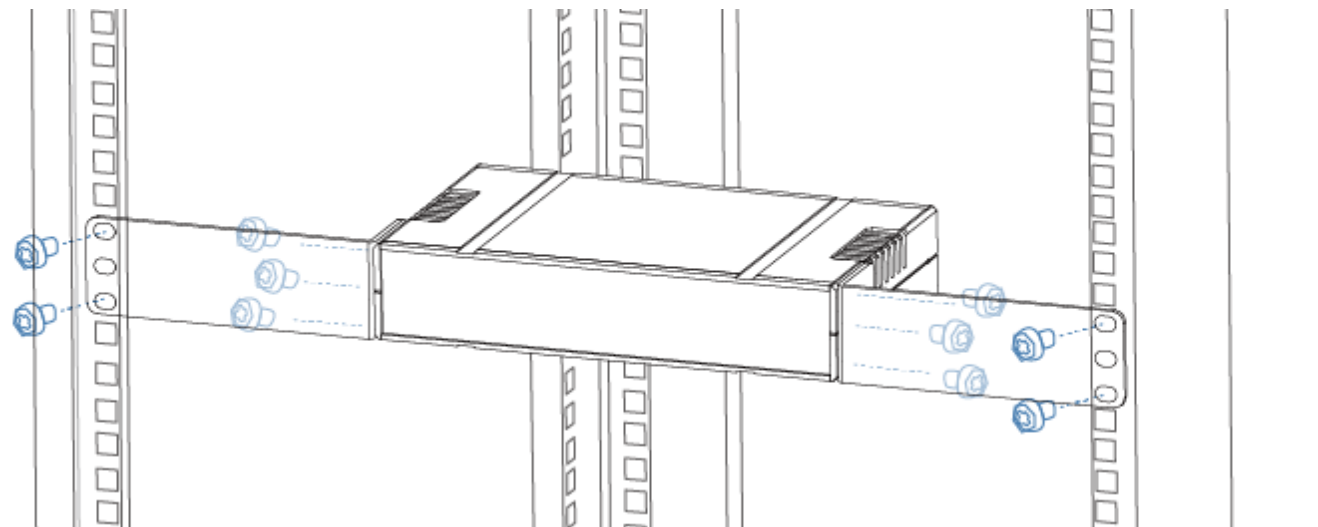
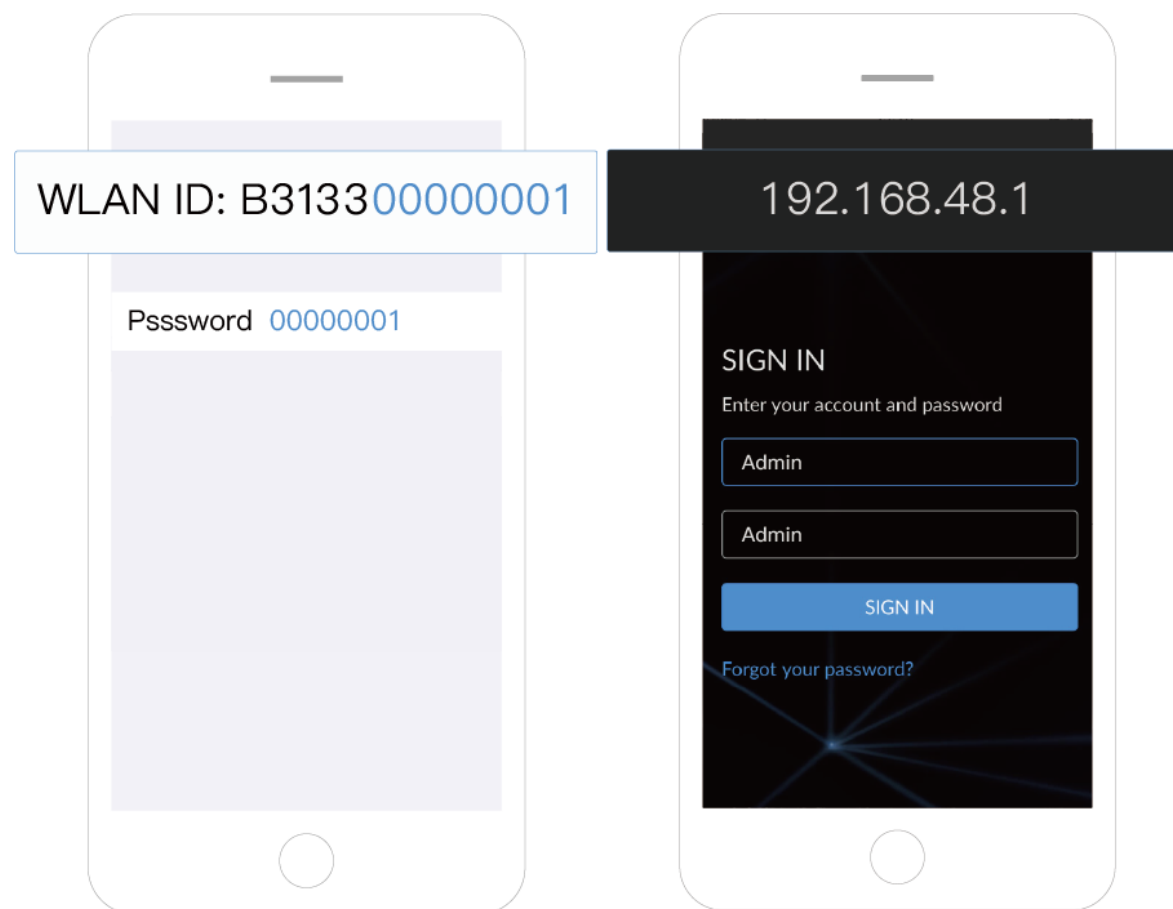

Fig2 One unit installation with long rack ears

Get Started With Ultra Encode



Access Web UI

Manage your device via wired networks, USB NET, or Wi-Fi.

1. Connect your device to your LAN and power it up.
The device may be powered by PoE+ through the ETH/PoE+ port or by DC input using the provided power adapter.
The device may connect to Ethernet through the ETH/PoE+ port or by Wi-Fi using the provided antennas.

⚠ To ensure a smooth video, you are recommended to connect to a wired network.

2. Access Web UI:
 - Tap on the LCD touch screen of the device front panel until you see a QR code, scan the QR code, or type the IP address below the QR code into your web browser.
Scanner (like smartphone) should be connected to the same local network as your device.
When the IP address shows 192.168.48.1, follow the steps below to join the device AP and access the Web UI.
 - i. Plug included Wi-Fi antenna when you want to connect to a wireless network.
 - ii. In your smartphone/tablet/laptop, turn on WLAN, search for and join the device AP named **Ultra Encode + (Serial number)**.
The AP names after your gear's **Serial number**, and the password

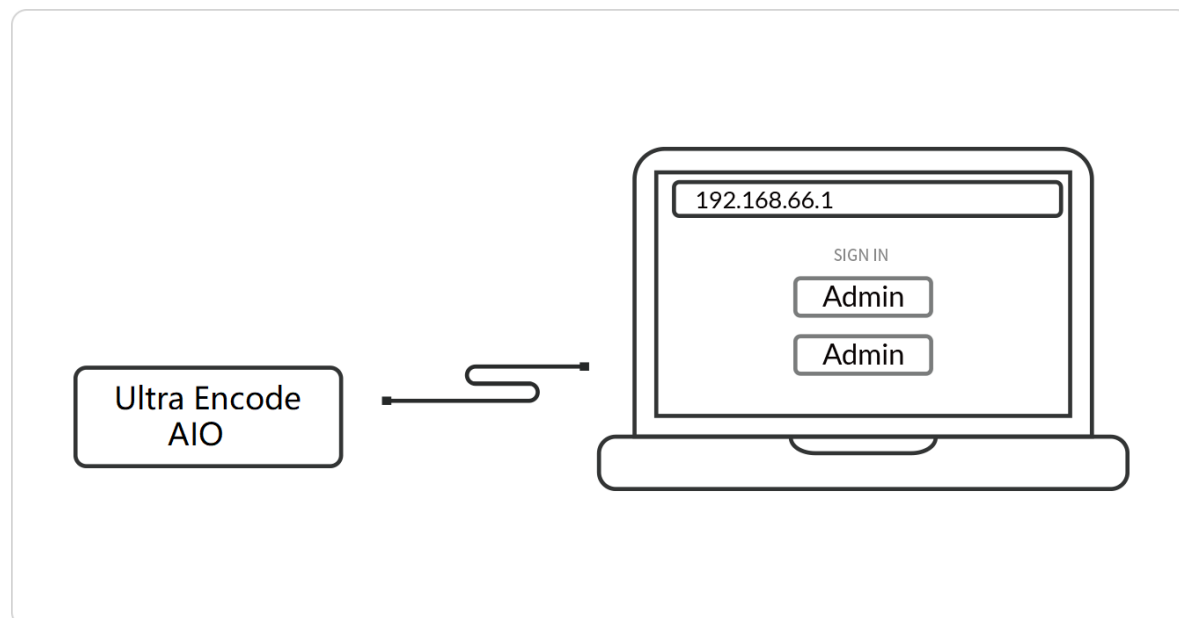
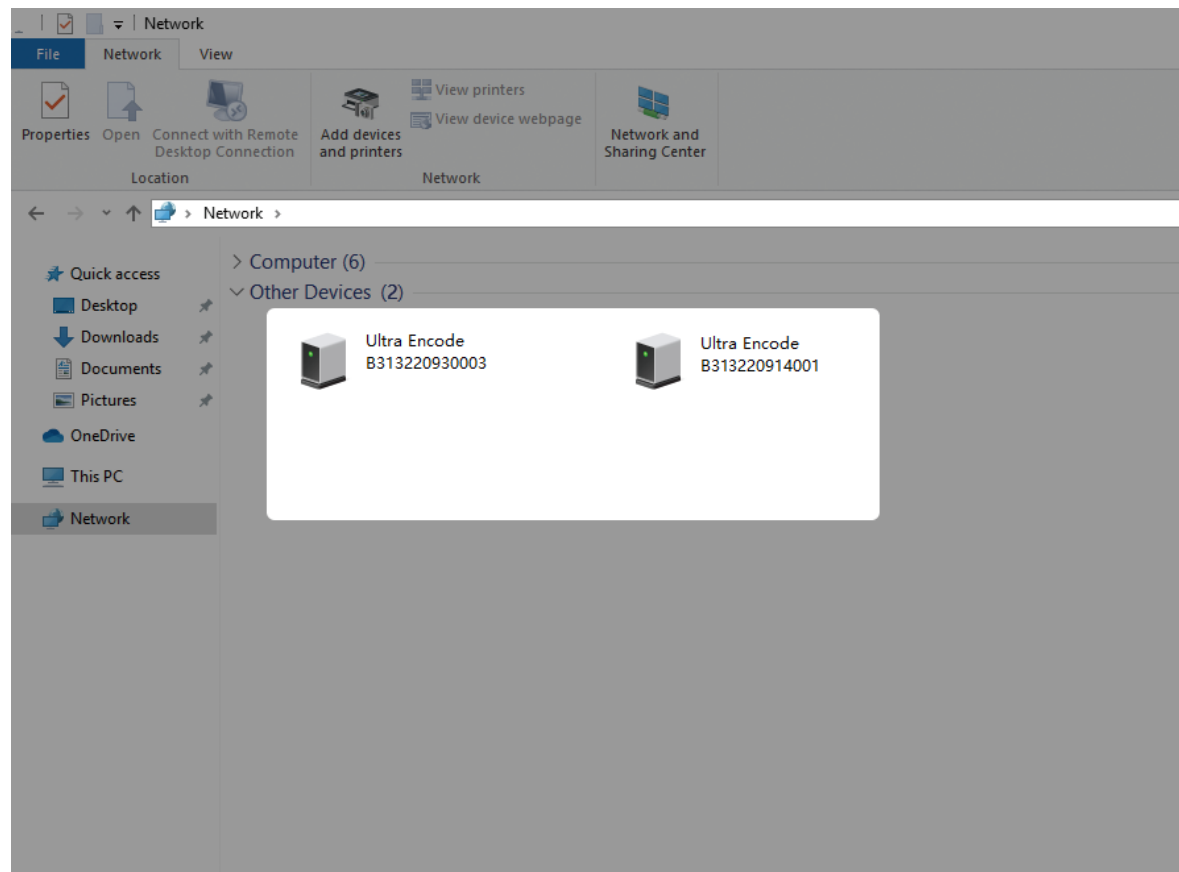

is the last 8-number of the serial number by default. For example, a serial number 313210101001 indicates the initial AP password is 10101001.

We recommend that the distance between the Web UI and the encoder should be within 10m.

- iii. In your web browser, enter 192.168.48.1 to open the Web UI.

⚠ Tap on the LCD screen, you can find the Web UI QR code, record and live status, network connection status and so on.

- Via File Explorer on Windows 7 and above
 - i. Open File Explorer in your PC, then locate your device in **Network > Other Devices**.
 - ii. Double click the device icon to open the sign in page of Web UI.
- Via USB NET, IP Address: 192.168.66.1
 - i. Connect the device CONFIG (a USB-C port on the back panel) to your computer using USB cable.
 - ii. Type the USB NET IP address 192.168.66.1 in your web browser to access the Web UI.
- Via device Wi-Fi AP, IP Address: 192.168.48.1
Refer to [the steps to join the device AP and access the Web UI](#).

MAGEWELL® English ▾

Ultra Encode AIO

SIGN IN

Enter your account and password

[Forgot your password?](#)

Set Device Name

💡 1. 1-32 characters
2. A-Z, a-z, 0-9, space and ._-+'[]()
3. Cannot begin or end with a space.



Next



Device name Serial number Input Sign

Initialization

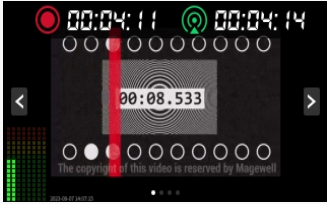
Follow the instructions of the Web UI to perform the device initialization and set a new device name.

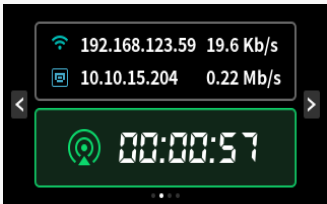
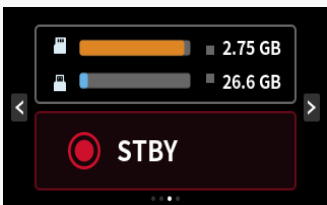
LCD Touchscreen

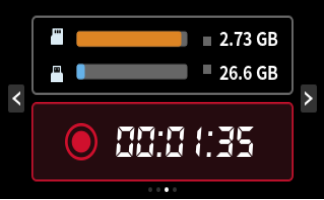
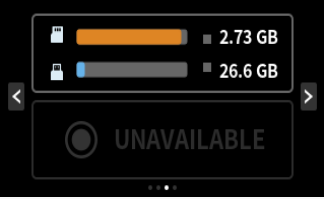
LCD Display	Description	Available Operation
	Display the preview image and audio meter.	Tap on the <> arrow to turn the page.
	Display the preview image, audio meter, record and live status.	Tap on the <> arrow to turn the page.
	Live ready.	Tap on the <> arrow to turn the page. Tap on the boxed area below to start streaming.
	Streaming	Tap on the <> arrow to turn the page. Tap on the boxed area below to stop streaming.
	Live unavailable.	Tap on the <> arrow to turn the page.
	Record ready.	Tap on the <> arrow to turn the page. Tap on the boxed area below to start recording.

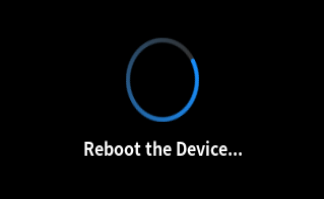
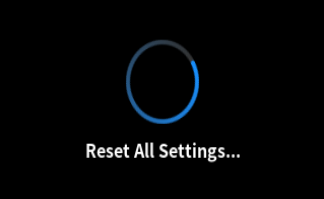
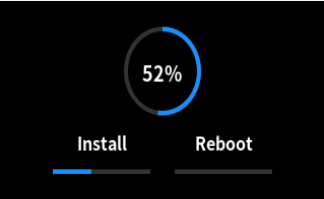
LCD Display	Description	Available Operation
	Recording	Tap on the <> arrow to turn the page. Tap on the boxed area below to stop recording.
	Record unavailable.	Tap on the <> arrow to turn the page.
	WebUI QRcode and IP address	Tap on the <> arrow to turn the page.
	Rebooting	None
	Resetting all settings	None
	Update process	None

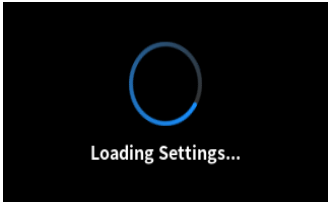
LCD Display	Description	Available Operation
	Loading setting files	None

Notice: Administrator users can set the LCD touchscreen function via "[System Settings](#) > [General Settings](#) > [LCD Settings](#)" on the Web UI.

Web UI Configuration

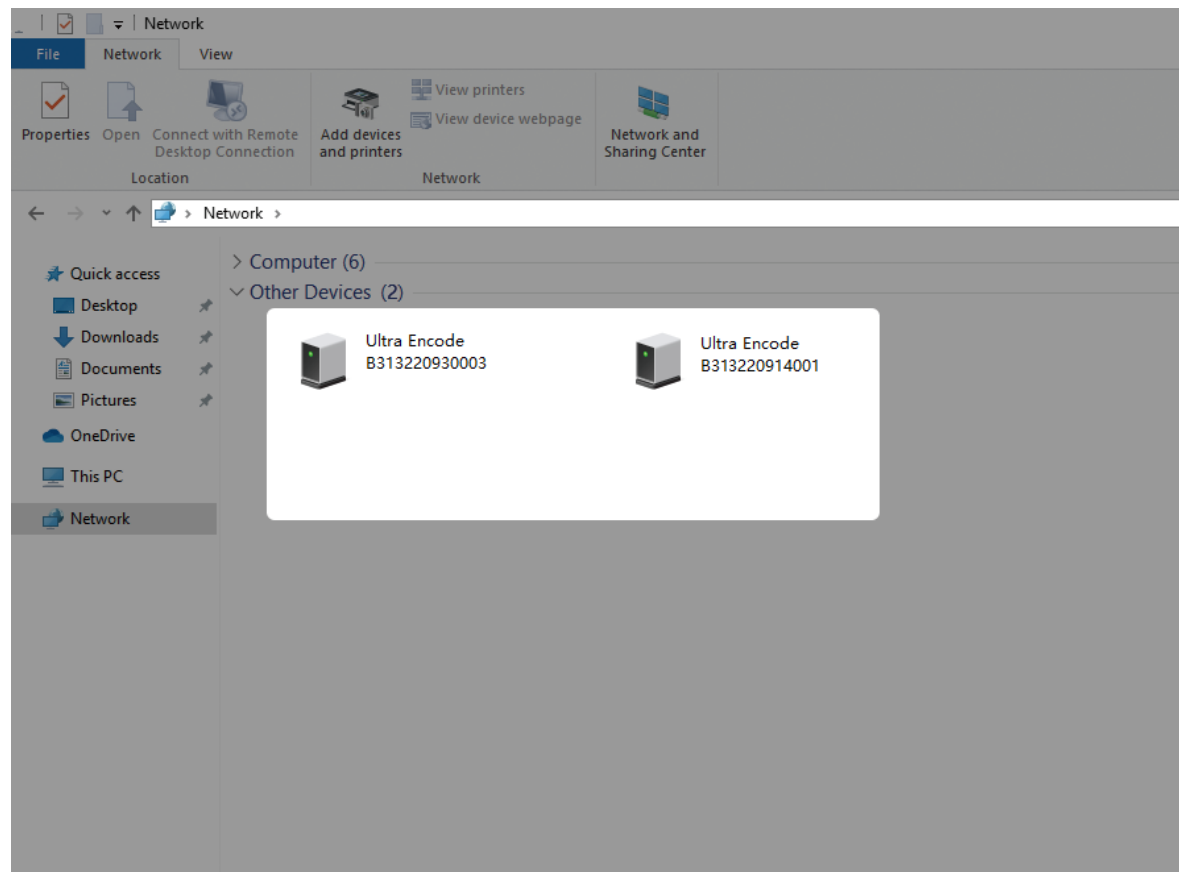

Fig1 Find your device in Windows > Network

Access the Web UI

A free tool, Web UI, is provided to monitor and manage device status and configuration. If you know your device's IP address, type it into your web browser to access the Web UI. Alternatively, you can access the Web UI via wired Ethernet, USB NET, or Wi-Fi following the steps below.

1. Connect your device to your LAN and power it up.
 The device may be powered by PoE+ through the ETH/PoE+ port or by DC input using the provided power adapter.
 The device may connect to Ethernet through the ETH/PoE+ port or by Wi-Fi using the provided antennas.

⚠ To ensure a smooth video, you are recommended to connect to a wired network.

2. Access Web UI:
 - Tap on the LCD touch screen of the device front panel until you see a QR code, scan the QR code, or type the IP address below the QR code into your web browser.
 Scanner (like smartphone) should be connected to the same local network as your device.
 When the IP address shows 192.168.48.1, follow the steps below to join the device AP and access the Web UI.
 - i. Plug included Wi-Fi antenna when you want to connect to a wireless network.

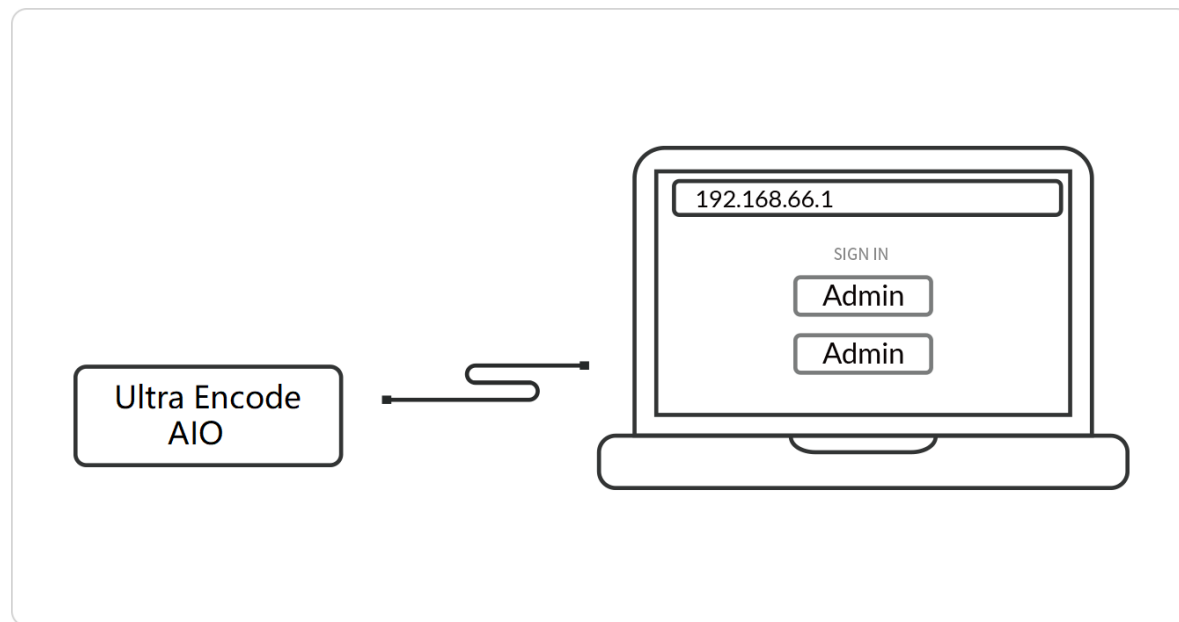

Fig2 USB NET connection

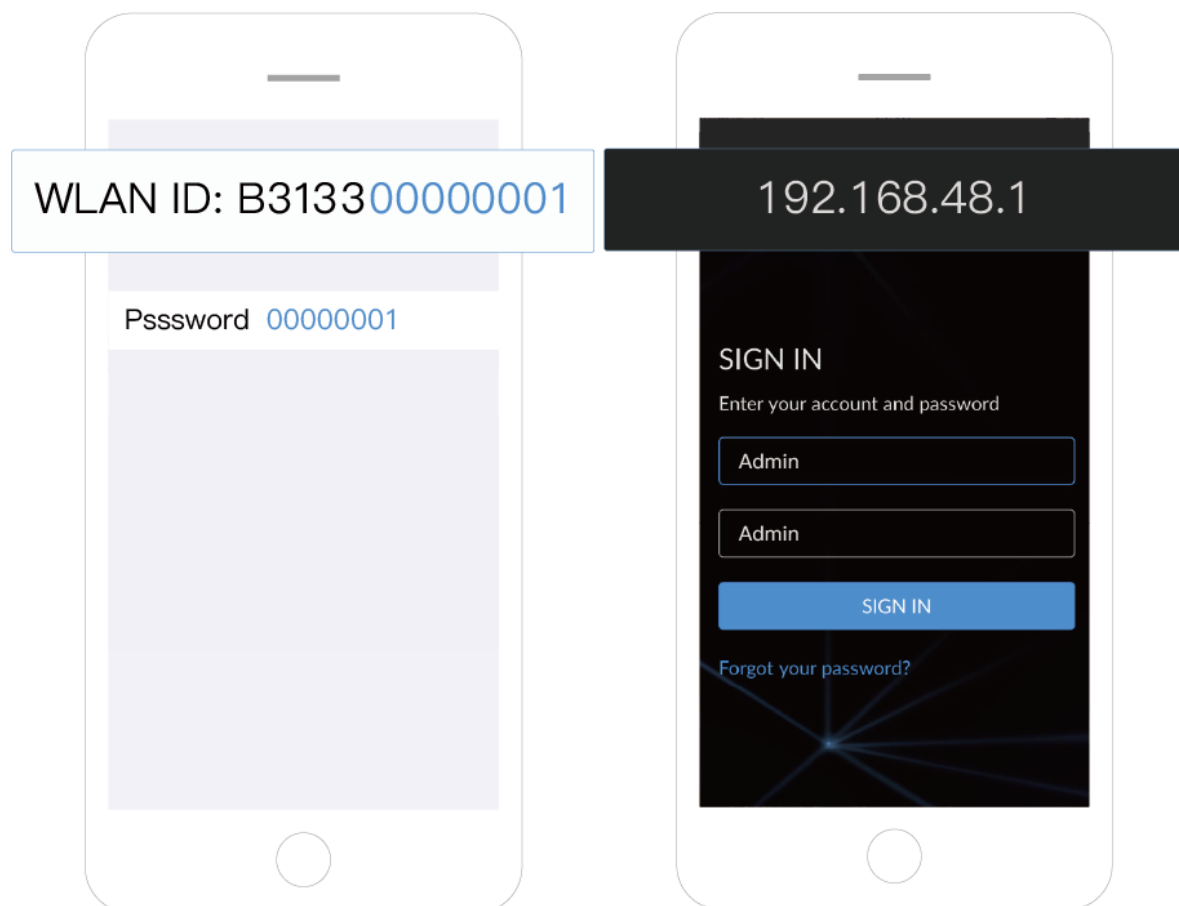

Fig3 AP connection

- ii. In your smartphone/tablet/laptop, turn on WLAN, search for and join the device AP named **Ultra Encode + (Serial number)**.
The AP names after your gear's **Serial number**, and the password is the last 8-number of the serial number by default. For example, a serial number 313210101001 indicates the initial AP password is 10101001.
We recommend that the distance between the Web UI and the encoder should be within 10m.
- iii. In your web browser, enter 192.168.48.1 to open the Web UI.

⚠ Tap on the LCD screen, you can find the Web UI QR code, record and live status, network connection status and so on.

- Via File Explorer on Windows 7 and above
 - i. Open File Explorer in your PC, then locate your device in **Network > Other Devices**.
 - ii. Double click the device icon to open the sign in page of Web UI.
- Via USB NET, IP Address: 192.168.66.1
 - i. Connect the device CONFIG (a USB-C port on the back panel) to your computer using USB cable.
 - ii. Type the USB NET IP address 192.168.66.1 in your web browser to access the Web UI.
- Via device Wi-Fi AP, IP Address: 192.168.48.1
Refer to [the steps to join the device AP and access the Web UI](#).



Fig4 Scan the QR code shown on the LCD to access device Web UI

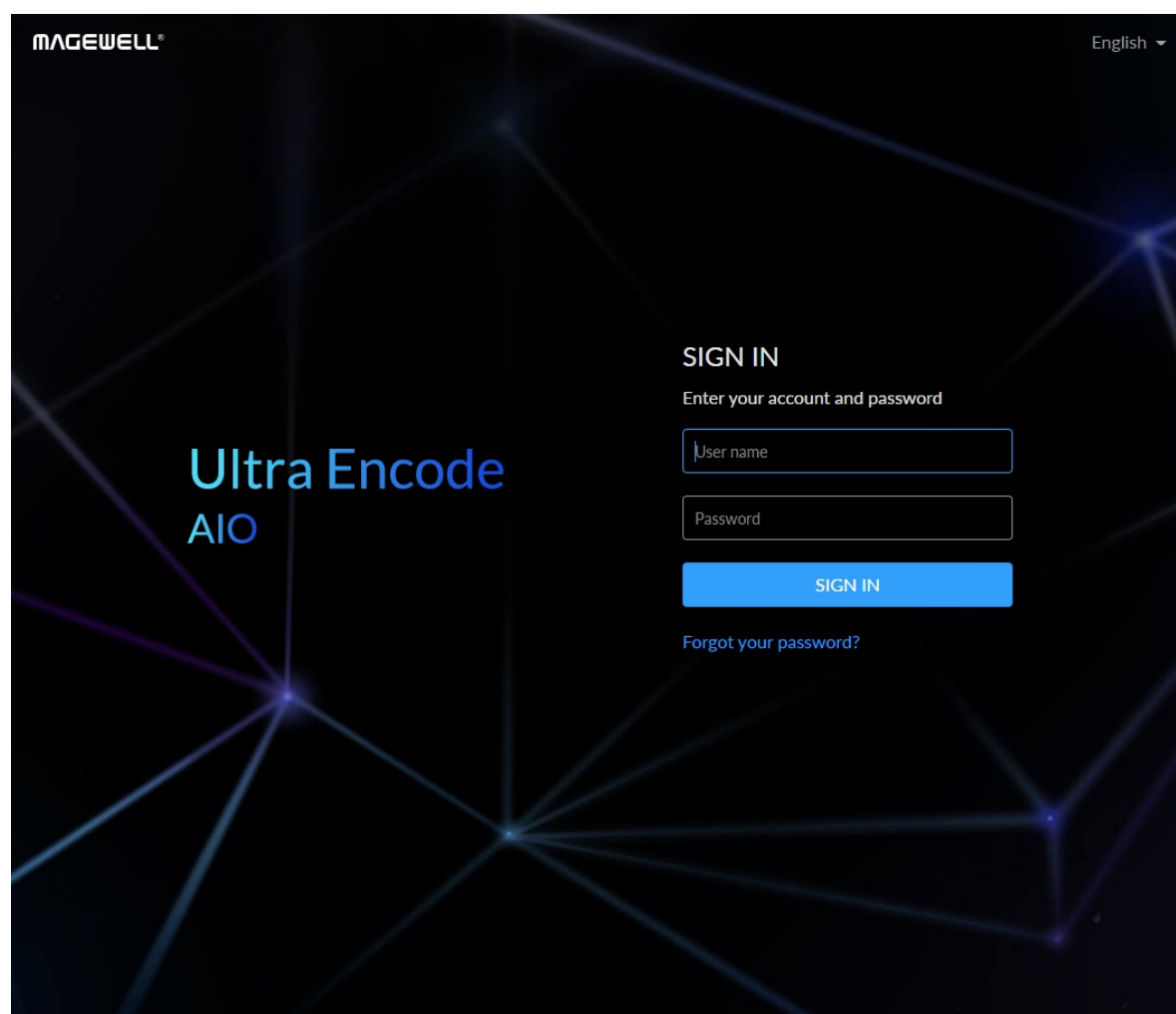

Sign In/Out

The Web UI allows multiple users to have read/write access to make configuration settings at the same time after logging-in. However, to avoid configuration conflicts, we do not recommend you to operate one device simultaneously.

1. Sign In: enter your account and password in the **SIGN IN** page.
 - The default administrator name and password are both Admin.
 - We recommend that you modify the admin password after initial logging-in.
2. Sign Out: click the down arrow symbol  behind the logging-in username at the top-right of the Web UI, and select **Sign out**.

Dashboard

On **Dashboard** page, you can:

- preview the thumbnail of the encoded video
- check device hardware information
- check system status
- set global volume and color
- check product module at the upper left corner

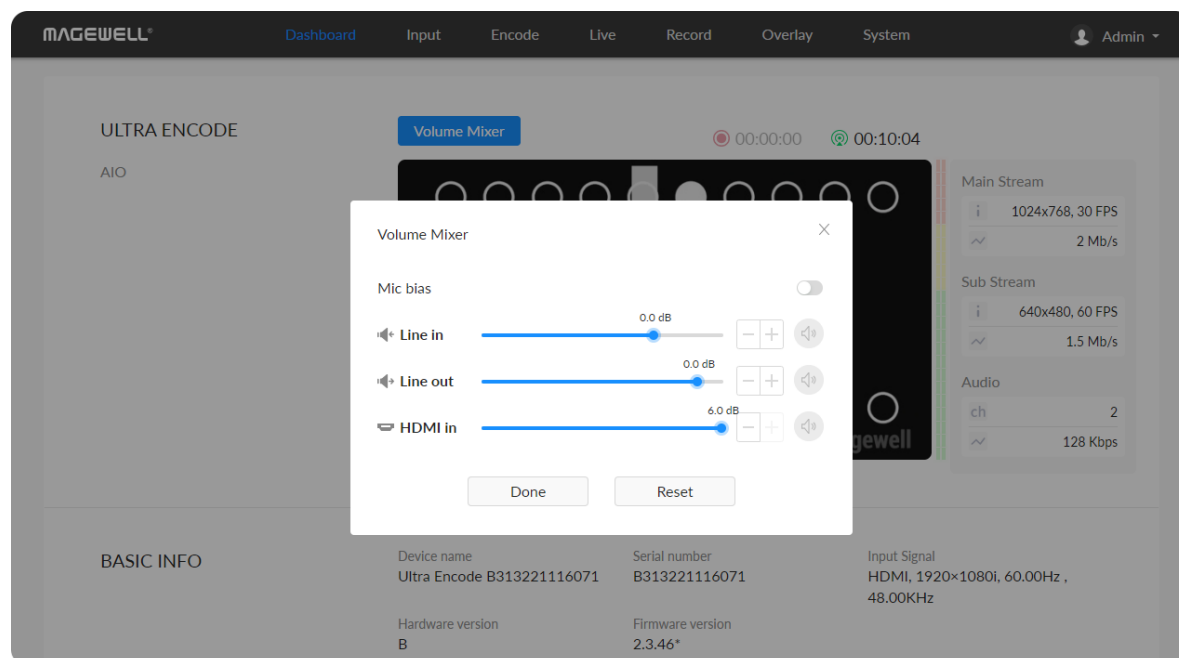

Set Volume

- **Mic Bias:** turn it on when connecting a microphone via line in. It allows flowing way power (around 2.3V) to the jack which makes the microphone sound. It is off by default.
- **LINE IN:** adjust the audio connected to the LINE IN. Click to fine tune the volume at 0.1dB.
- **LINE OUT:** adjust the LINE OUT audio which remixes audio embedded in input signal and LINE IN. Click to fine tune the volume at 0.1dB.
- **HDMI/SDI IN:** adjust input signal volume. Click to fine tune the volume at 0.1dB.
 - The audio channel is consistent with the signal selected in the **Input > Source > Mixer > Format**. You can set it to follow SDI or HDMI in on the [Input > Source](#) part.
 - : mute current channel
 - : restore current channel to default value

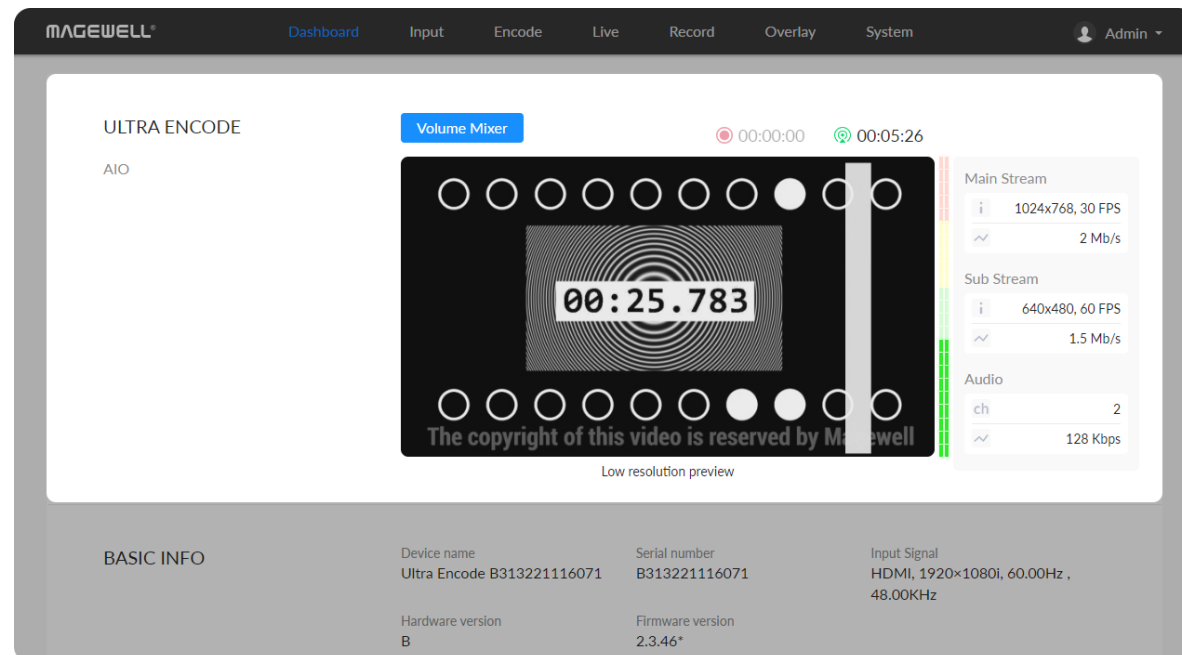

- **Reset:** restore all settings of the volume to default settings
- **Done:** click to save your configuration

Preview Thumbnails

Thumbnails, with a low resolution of 640x360, give you a quick snapshot of video being encoded.

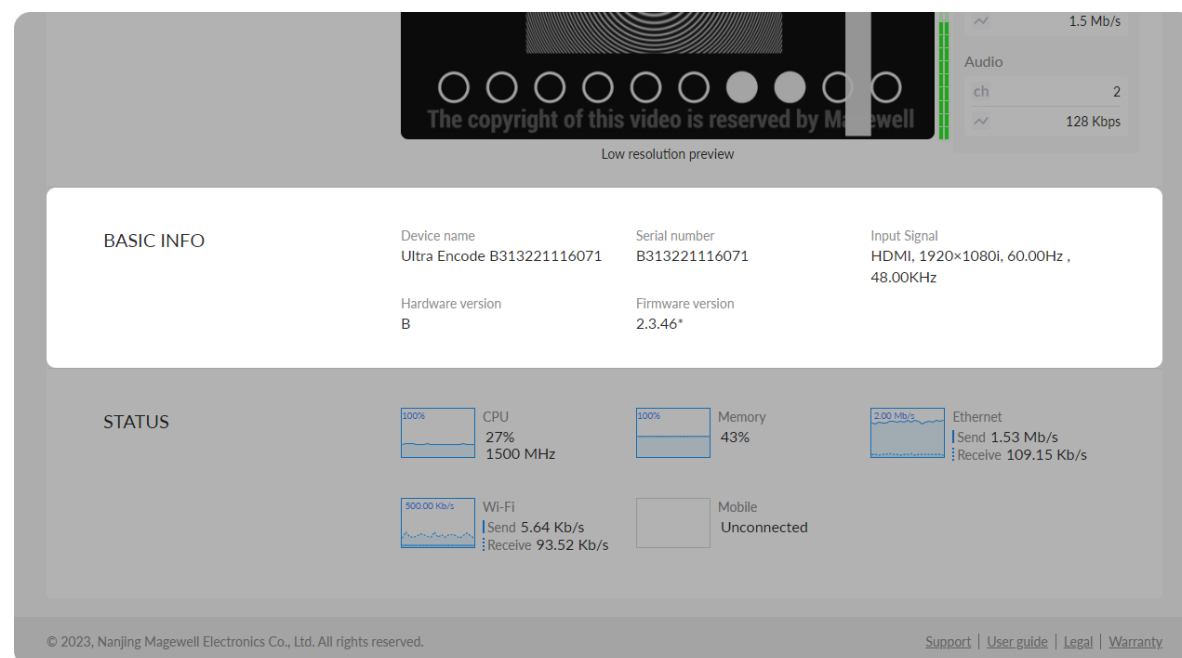

Check BASIC INFO

- **Device name:** device name of your unit. You can modify the device name in the [System > General > Device name](#) section.
- **Serial number:** serial number of your unit, which is also marked on your device.
- **Input Signal:** current input signal format.
- **Hardware version:** hardware version of your unit.
- **Firmware version:** current firmware version that is installed in your unit. You can update the firmware, via the [System > Firmware](#) tab.

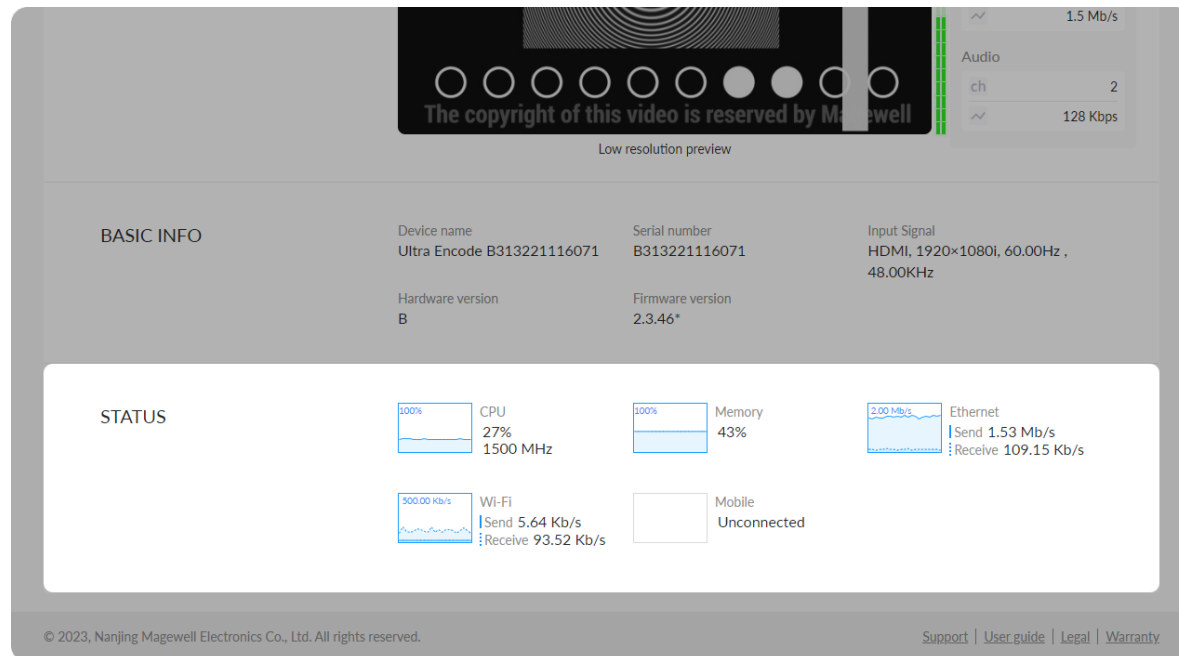

Check Device STATUS

- Gives you an overview of your system CPU, memory usage, network usage in real-time in order to evaluate the device performance & health.

Input

Click and enter the **Input** tab to check the input signal information detected by the device.

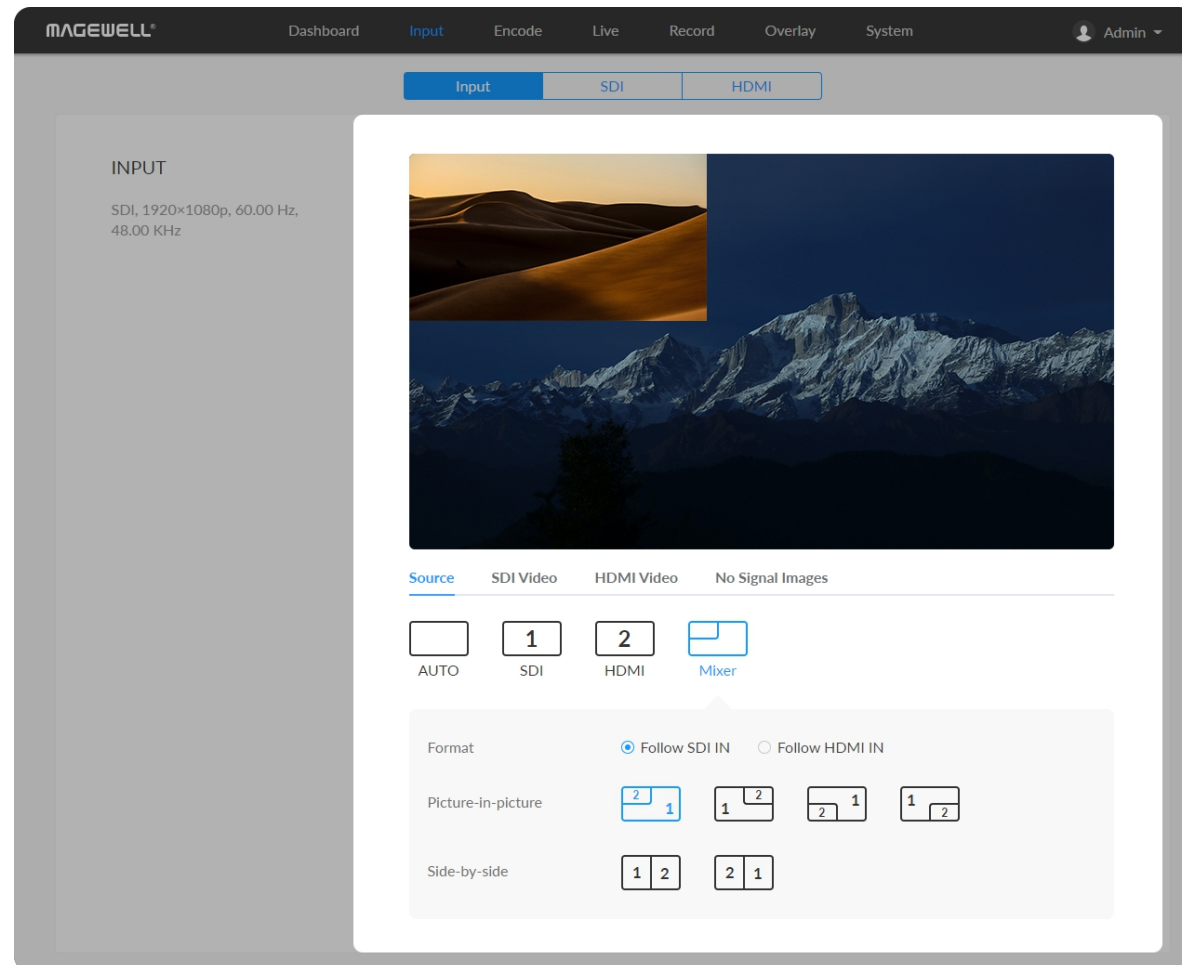

Set Input Source

When there are multiple input sources, the signal locked first will be previewed by default.

- **Auto:** When selected, the input signal that is locked first is previewed by default.
- **SDI:** click to preview the SDI signal.
- **HDMI:** click to preview HDMI signal.
- **Mixer:** you can combined the 2 input signals in different ways as follows.
 - **Format:** Set the resolution and frame rate of the combined signal. It can be set to "Follow SDI IN" or "Follow HDMI IN". When there is only SDI input but no HDMI signal, it needs to be manually modified to "Follow SDI IN". Otherwise, it would be blank.
 - **Picture-in-picture:** A picture-in-picture effect is when two videos or images are shown at the same time with one smaller video or image on top of a larger one.
 - **Side-by-side:** If the two video images are shown at the same time at the same size, it is side-by-side effect. You can specify the left/right position of the videos.

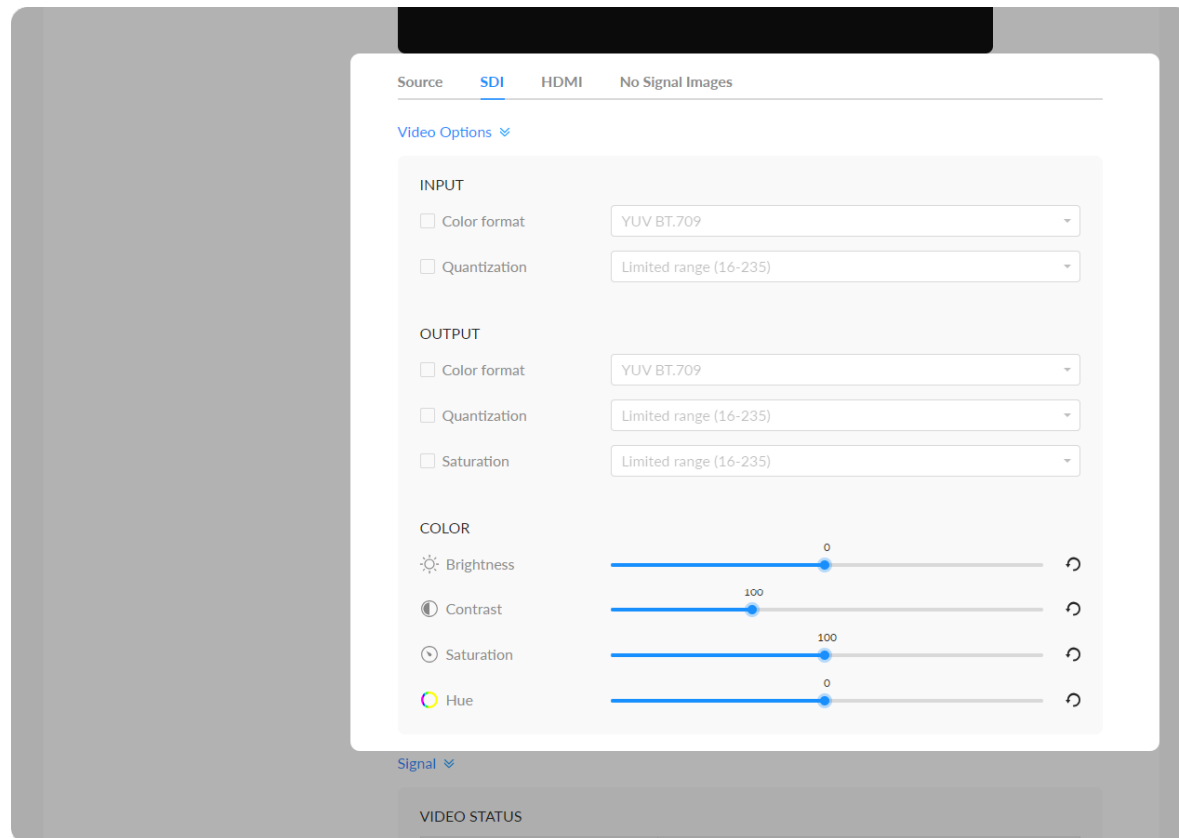

Set SDI/HDMI INPUT

- **Color format:** input video color format. Check the box to select other options, including RGB, YUV BT.601, YUV BT.709, YUV BT.2020.
- **Quantization:** input quantization range. Check the box to select other options, including Full range(0-255), Limited range(16-235).

Set SDI/HDMI OUTPUT

- **Color format:** check the box to select other options, including YUV BT.601, YUV BT.709.
- **Quantization:** check the box to select other options, including Full range(0-255), Limited range(16-235).
- **Saturation:** check the box to select other options, including Full range(0-255), Limited range(16-235), Extended GAMUT range(1-254).

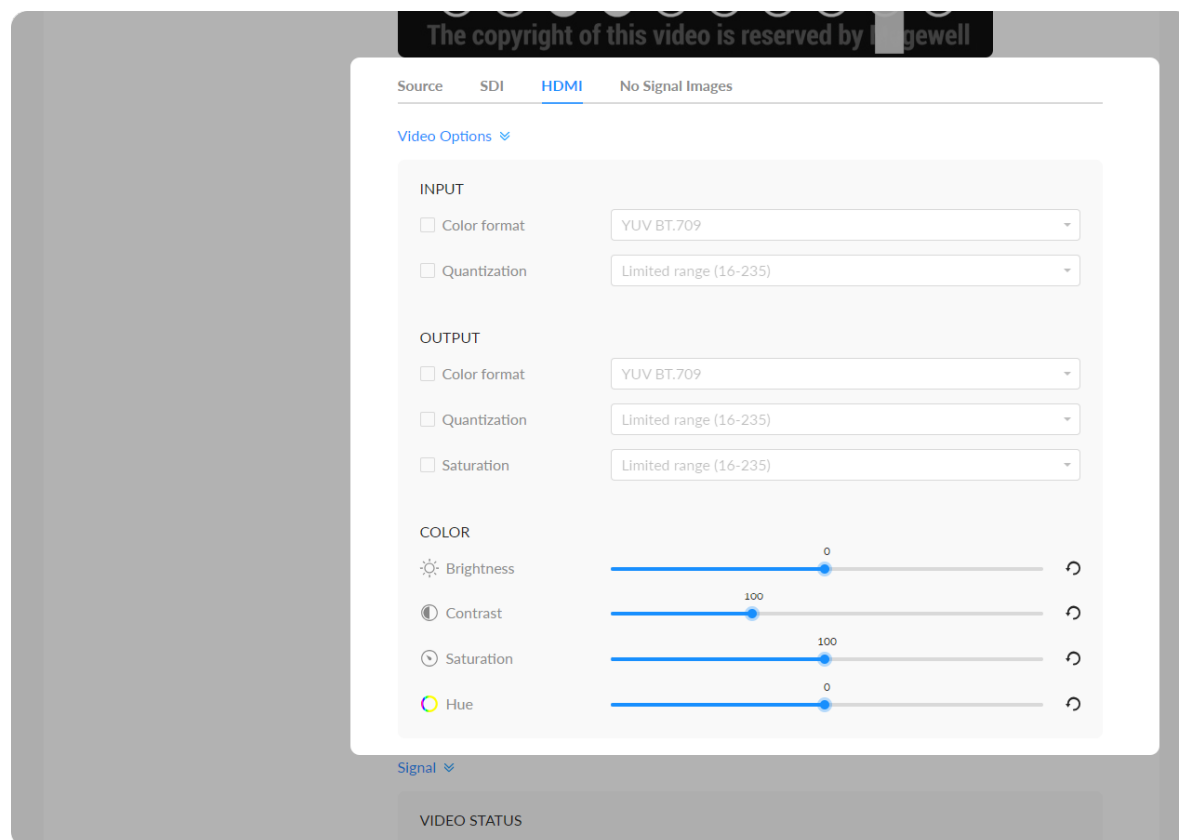

Set SDI/HDMI Color

Set color format of preview and stream video.

- **Brightness:** range from -100 to 100, the default value is 0.
- **Contrast:** range from 50 to 200, the default value is 100.
- **Saturation:** range from 0 to 200, the default value is 100.
- **Hue:** range from -90 to 90, the default value is 0.
- **Reset:** Click  icon to restore the current setting to default value.

Signal 

VIDEO STATUS	
Resolution	1920×1080p, 60.00Hz
Color depth	10
Sampling	4:2:2
Aspect ratio	16:9
Color format	BT.709
Frame struct	2D
Quantization range	Limited
Saturation range	Limited

AUDIO STATUS	
Sampling	48000, 24 bits
Channels	16

SDI STATUS	
Link type	Single link
Link speed	3G
Stream type	Single stream
Level B	False
Interlaced	False
Assignment	0
ST 352 payload ID	0x0100CB89
H total	2200 Pixels
V total	1125 Lines
H active	1920 Pixels
V active	1080 Lines

Check VIDEO STATUS

- **Resolution** shows the input video pixel resolution & frame rate.
- **Color depth** shows the input video color depth, in bits.
- **Sampling** shows the input video color sampling format.
- **Aspect ratio** shows the input video aspect ratio.
- **Color format** shows the input video color encoding format.
- **Frame struct** shows the input video frame type, 2D or 3D.
- **Quantization range** shows the quantization range, Full or Limited.
- **Saturation range** shows the saturation range, e.g. Full or Limited.

Check AUDIO STATUS

- **Sampling** shows the input audio sampling rate and bit depth.
- **Channels** shows the number of input audio channels detected.

Check SDI STATUS

NOTE: This parameter is available for SDI products.

- **Link type** shows link type of input SDI signal, including single link, dual link, quad link.
- **Link speed** shows the current data speed.
- **Stream type** shows the number of streams that is contained in the data source.
- **Level B** shows whether the input signal is level B format.
- **Interlaced** shows whether the input signal is interlaced.
- **Assignment** shows the link number, especially when be fed into a source of

Signal 

VIDEO STATUS	
Resolution	1920×1080i, 60.00Hz
Color depth	8
Sampling	4:4:4
Aspect ratio	16:9
Color format	BT.709
Frame struct	2D
Quantization range	Limited
Saturation range	Limited

AUDIO STATUS	
Sampling	48000, 16 bits
Channels	2

HDMI STATUS	
Mode	HDMI
HDCP encrypted	False
VIC	5
IT content	False
Pixel rate	74.25 MHz
Timing-H total	2200 Pixels
Timing-H active	1920 Pixels
Timing-H front porch	88 Pixels
Timing-H sync width	44 Pixels
Timing-H back porch	148 Pixels
Timing-V total	1125 Pixels
Timing-V active	540 Pixels
Timing-V front porch	2 Pixels
Timing-V sync width	5 Pixels
Timing-V back porch	15 Pixels

multi-link interfaces.

- **ST 352 payload ID** shows the SMPTE ST 352 video payload identification code for SDI.
- **H total** shows the total number of pixels, horizontally.
- **V total** shows the total number of pixels, vertically.
- **H active** shows the number of active pixels, horizontally.
- **V active** shows the number of active pixels, vertically.

Check HDMI STATUS

NOTE: This parameter is available for HDMI products.

- **Mode** shows the signal type (which is always HDMI for the HDMI product).
- **HDCP encrypted** shows whether the signal source is HDCP encrypted. In accordance with the related laws and regulations, the device doesn't process HDCP encrypted signals, so the value is None.
- **VIC** Video Identification Code, which is defined for CEA formats.
- **IT content** shows whether the transmission package is content.
- **Pixel rate** shows the maximum number of pixels the unit could possibly write to the memory in one second.
- **Timing-H total** shows the total number of pixels, horizontally.
- **Timing-H active** shows the number of active pixels, horizontally.
- **Timing-H front porch** shows the Front Porch width in pixels.
- **Timing-H sync width** shows the Sync Pulse width in pixels.

- **Timing-H back porch** shows Back Porch width in pixels.
- **Timing-V total** shows the total number of pixels, vertically.
- **Timing-V active** shows the number of active pixels, vertically.
- **Timing-V front porch** shows the size of the vertical Front Porch in pixels.
- **Timing-V sync width** shows the width of the vertical Sync Pulse in pixels.
- **Timing-V back porch** shows the size of the vertical Back Porch in pixels.

Check HDMI INFO FRAME

The info frames vary from different signal sources, AVI/AUDIO/SPD/VS may be included.

- **Type** shows the packet type.
- **Version** shows the packet Version.
- **Length** shows the length of the AVI InfoFrame payload.
- **Checksum** shows the packet checksum.
- **Data** shows the InfoFrame payload.

The screenshot displays a software interface for managing EDID. The main window is titled 'INFO FRAME' and is divided into two sections: 'AVI' and 'AUDIO'. Each section contains a table with fields for Type, Version, Length, Checksum, and Data.

INFO FRAME	
AVI	
Type	0x82
Version	0x02
Length	13 bytes
Checksum	0x72
Data	50 A8 00 05 00 00 00 00 00 00 00 00 00
AUDIO	
Type	0x84
Version	0x01
Length	10 bytes
Checksum	0x70
Data	01 00 00 00 00 00 00 00 00 00

Below the tables, there is a section for 'EDID' with a dropdown arrow, and an 'INPUT PORT' section with the text: 'Manage EDID of the input port. SmartEDID™ solves conflicts when connecting a loop-through device.'

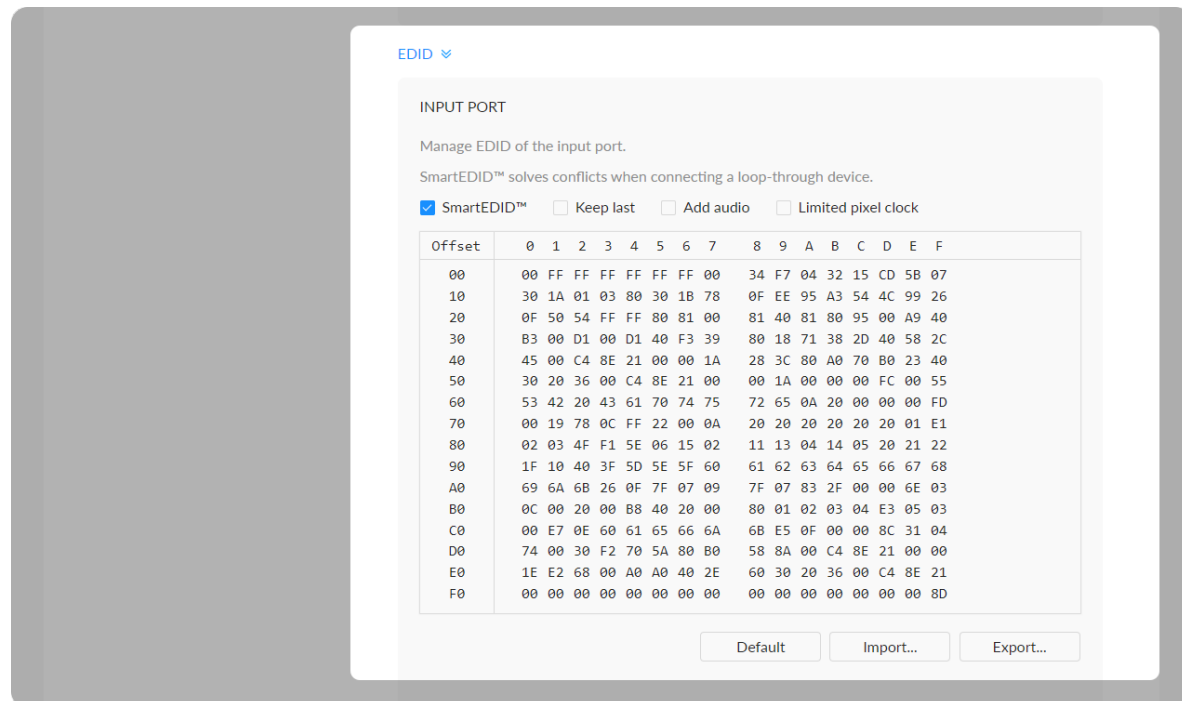

EDID

Click the **EDID** to check the EDID information. By clicking **Reset to Default**, you can cancel your settings.

EDID is only available for products supporting HDMI signal.

Set SmartEDID™

NOTE: This function is available for HDMI products.

- **SmartEDID™**
 - SmartEDID™ is enabled by default. When it is disabled, other related functions can not be set.
 - Depending on the input capability of the encoder and that of the device connected to the loop-through interface, the encoder will smartly select to send the EDID to the video source device, to ensure both the encoder and the loop-through device can obtain the signal they support.
- **Keep last**
 - Keep the last EDID value used.
 - This function is disabled by default. To enable it, the SmartEDID function should also be enabled. When Keep Last is enabled and the loop-through device is disconnected, the current EDID will still be used. The encoder will continue receiving signal so the video capture and encoding continues. Otherwise, the encoder will resend its EDID to the source device for it to redetermine what format of signal to send. As a result, there could be an interruption to the source signal for a short time.
- **Add audio**
 - Force the source device to output audio.

- If users connect a monitor which doesn't support audio to the loop-through output, the source device will decide not to output audio. As a result, the device will not get any audio input. If **Add Audio** is enabled, the device will communicate with the video source device, forcing it to output audio.
- **Limited pixel clock**
 - If enabled, when the pixel resolution of the loop-through device is beyond the capability of the device, a lower pixel resolution will be used in order to avoid the output producing a blank screen.

Set INPUT EDID

Any of the following actions can be performed on the input EDID of the device.

- **Default:** Click **Default** to reset the current EDID to default values.
- **Import:** Click and select an EDID file to import a EDID file.
- **Export:** Click and set the file name to export the current EDID as a .bin file.

The screenshot shows a software interface with a 'LOOP-THRU PORT' window. At the top, there is a table of hexadecimal data. Below it are buttons for 'Default', 'Import...', and 'Export...'. The 'LOOP-THRU PORT' window contains a table with 'Offset' and hexadecimal values for each hex digit (0-F). An 'Export...' button is located at the bottom right of the window.

Offset	0	1	2	3	4	5	6	7	8	9	A	B	C	D	E	F
00	00	FF	FF	FF	FF	FF	FF	00	34	F7	04	32	15	CD	58	07
10	30	1A	01	03	80	30	18	78	0F	EE	95	A3	54	4C	99	26
20	0F	50	54	FF	FF	80	81	00	81	40	81	80	95	00	A9	40
30	B3	00	D1	00	D1	40	F3	39	80	18	71	38	2D	40	58	2C
40	45	00	C4	8E	21	00	00	1A	28	3C	80	A0	70	B0	23	40
50	30	20	36	00	C4	8E	21	00	00	1A	00	00	00	FC	00	55
60	53	42	20	43	61	70	74	75	72	65	0A	20	00	00	00	FD
70	00	19	78	0C	FF	22	00	0A	20	20	20	20	20	20	01	E1
80	02	03	4F	F1	5E	06	15	02	11	13	04	14	05	20	21	22
90	1F	10	40	3F	5D	5E	5F	60	61	62	63	64	65	66	67	68
A0	69	6A	6B	6C	6D	6E	6F	70	71	72	73	74	75	76	77	78
B0	0C	00	20	00	B8	40	20	00	80	01	02	03	04	E3	05	03
C0	00	E7	0E	60	61	65	66	6A	6B	E5	0F	00	00	8C	31	04
D0	74	00	30	F2	70	5A	80	B0	58	8A	00	C4	8E	21	00	00
E0	1E	E2	68	00	A0	A0	40	2E	60	30	20	36	00	C4	8E	21
F0	00	00	00	00	00	00	00	00	00	00	00	00	00	00	00	8D

Check Loop-through EDID

Loop-through EDID shows the EDID of the connected loop-through device.

NOTE: This section is available for HDMI products.

- **Export:** Click and set the file name to export the current EDID as a .bin file.

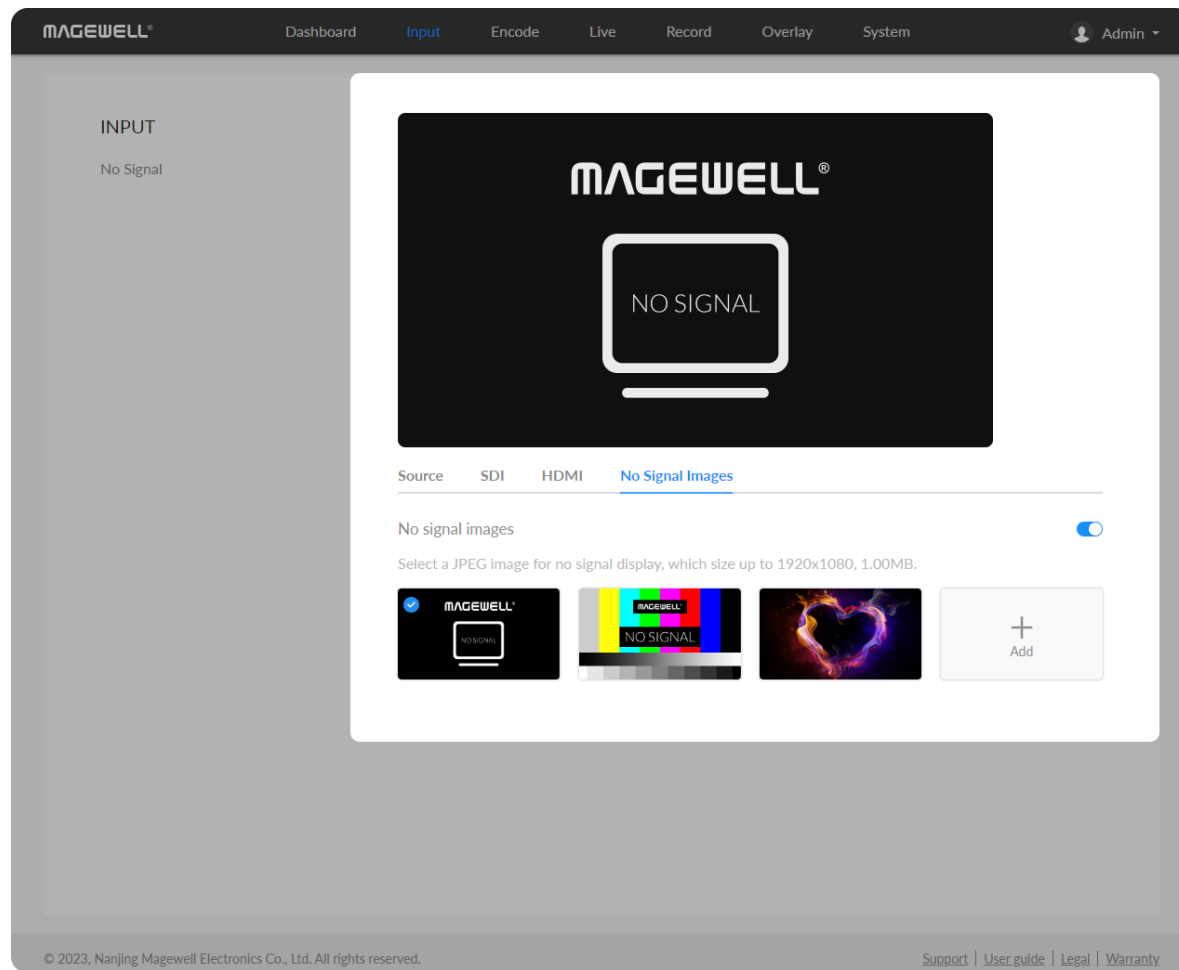

NO SIGNAL IMAGES

- Select a JPEG image for no signal display, which size up to 1920x1080, 1MB. The device provided 2 pictures can not be deleted. By default, the switch is on.
- **Add:** You can add 2 more JPEG photos sizing up to 1920x1080, 1.00 MB.
- **Delete:** click the delete icon  to remove the uploaded image from your device.

Encode

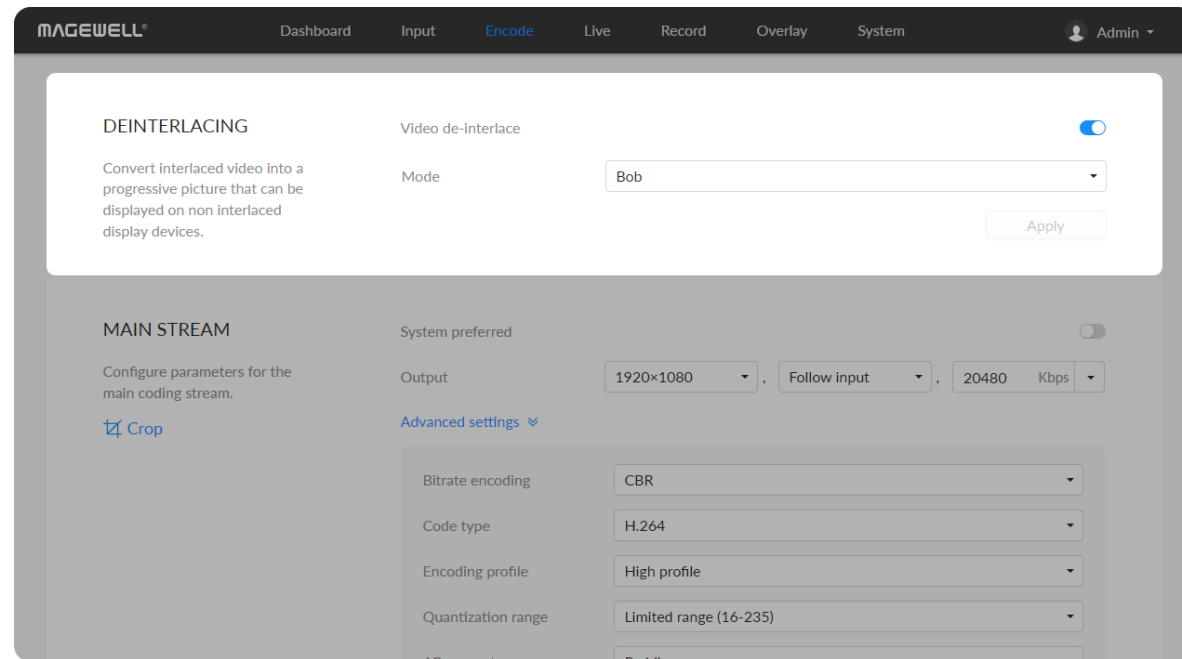

Deinterlacing

For the interlaced signal encoded with HEVC for both streams, only when the input [Source](#) is set to Auto, SDI or HDMI, the de-interlacing function is turned off, and the HEVC stream encoded in the interlaced signal mode can be output. A "Mixer" source does not support the output of interlaced signals.

- **Video de-interlace:** by default, the switch is on. The dual streams must be HEVC(H.265) for turning off de-interlace. After turning off, only HEVC is available for the code type of the dual streams.
 - **Mode:** when the Video de-interlace switch is on, it can be set to Blend or Bob, with Bob as the default.
- **Apply:** click Apply after configuration.

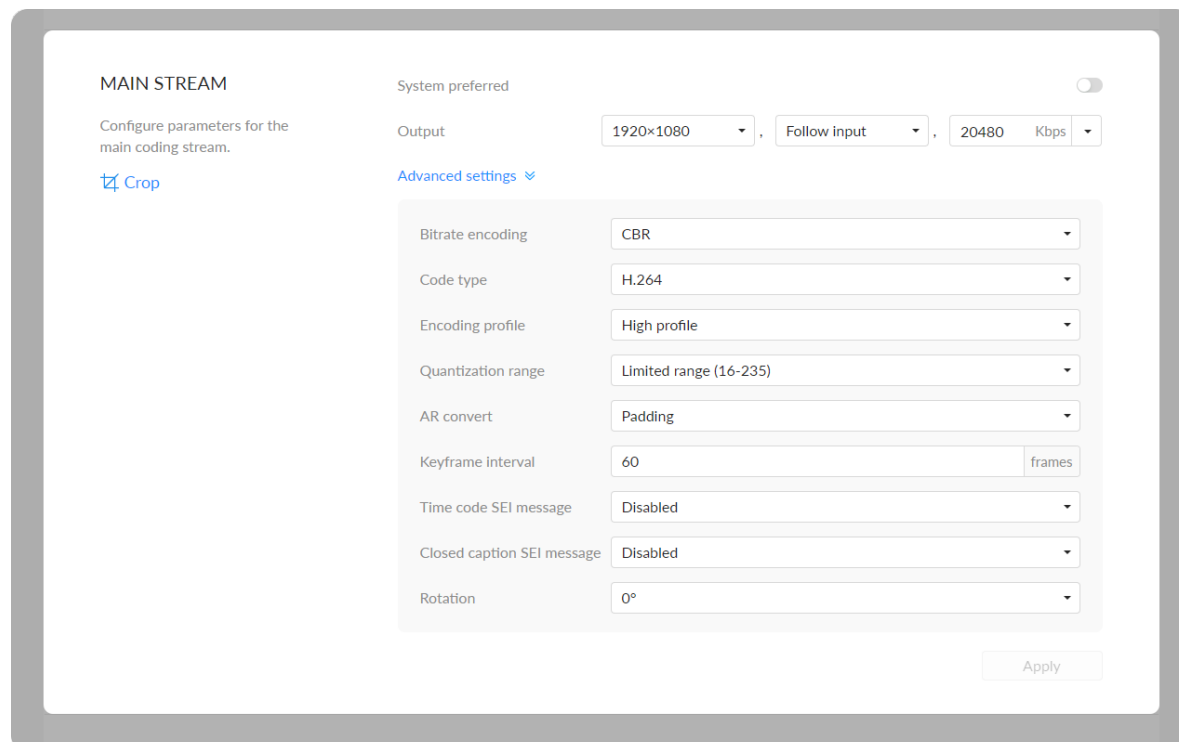
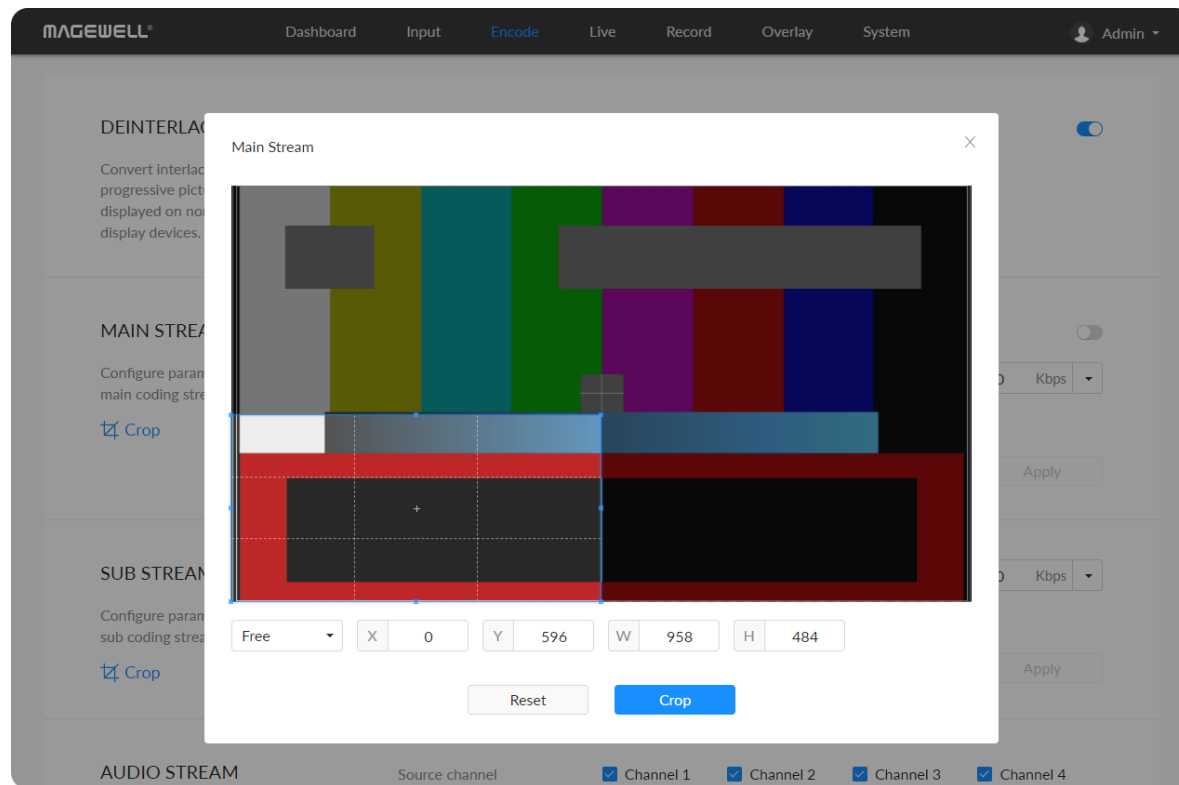

Set MAIN STREAM

- Crop:** click on the  icon, and specify the cropping ratio as Free, 1:1, 3:2, 4:3, 16:9 in the pop-up window. You can drag and drop the crop border to set the crop window. Or specify the the left (x) and top (y) edges of the containing block and the specified width (w) and height (h) of the rectangle. The cropped image will be displayed on the Live, Overlay and LCD screens simultaneously. Click "Reset", the coordinates of the cropping frame will be changed to (0, 0, the resolution WH of the Output configuration).
- System preferred:** by default, it is on, and the output format would be consistent with the input signal. Turn it off to custom the code format. You can check the format on the right side of the thumbnail of the device status. System preferred is not available for NDI[®]|HX3.
- Output:** by default, it follows input resolution, frame rate, bitrate. Only the resolution and frame rate can be specified, and the bit rate is determined by NDI[®] and is filled in automatically for NDI[®]|HX3.
- Bitrate Encoding:** options are CBR (default) and VBR. Live stream at CBR (Constant Bitrate) for bandwidth stability. VBR(Variable Bitrate) files vary the amount of output data per time segment. CBR is the only choice for NDI[®]|HX3. And you need to set quantization parameters for VBR. The quantization parameter controls the amount of compression for every macroblock in a frame. Large values mean that there will be more compression, lower quality, and lower bandwidth. Lower values mean the opposite.
 - Min QP:** available when **Bitrate Encoding** is VBR. The range of values is 0 to 50. The default value is 4. And we recommend you use the default value and do fine adjustment if needed.

- **Max QP:** available when **Bitrate Encoding** is VBR. The range of values is 1 to 51. The default value is 40, and it must be larger than the Min QP value. We recommend you use the default value and do fine adjustment if needed.
- **Code type:** options are H.264 (default) and H.265(HEVC) encoders.
- **Encoding profile:** for H.264 encoder, the profiles can be High (default)/Main profile/Baseline. For H.265 (HEVC), it can be Main profile.
- **Quantization range:** options are Full range(0-255) and Limited range(16-235) (default).
- **AR convert:** options are Ignore, Cropping and Padding (default).
- **Keyframe interval:** options are 0.5, 15-300 frames, the default is 60. A smaller number will result in a larger file size and less buffer time for seeing the first frame. To ensure a clear and smooth live broadcast, it is recommended that the key frame interval be less than or equal to 60 frames. Keyframe interval is fixed at 20 for NDI[®]|HX3.
- **Time code SEI message:** options are off (default), system clock, and embedded. Turn on the switch to get A/V sync between multiple devices which support this SEI message as well.
- **Closed caption SEI message:** turn on the switch to encode closed captions (if present in the input signal) into H.264/H.265 (HEVC) SEI message. Native CEA-608 and 608 over 708 captions are both supported. It is off by default. **Note that it is only supported by SDI product.**
- **Rotation:** options are 0°(default), 90°, 180°, and 270°. Rotation will make overlay not working.

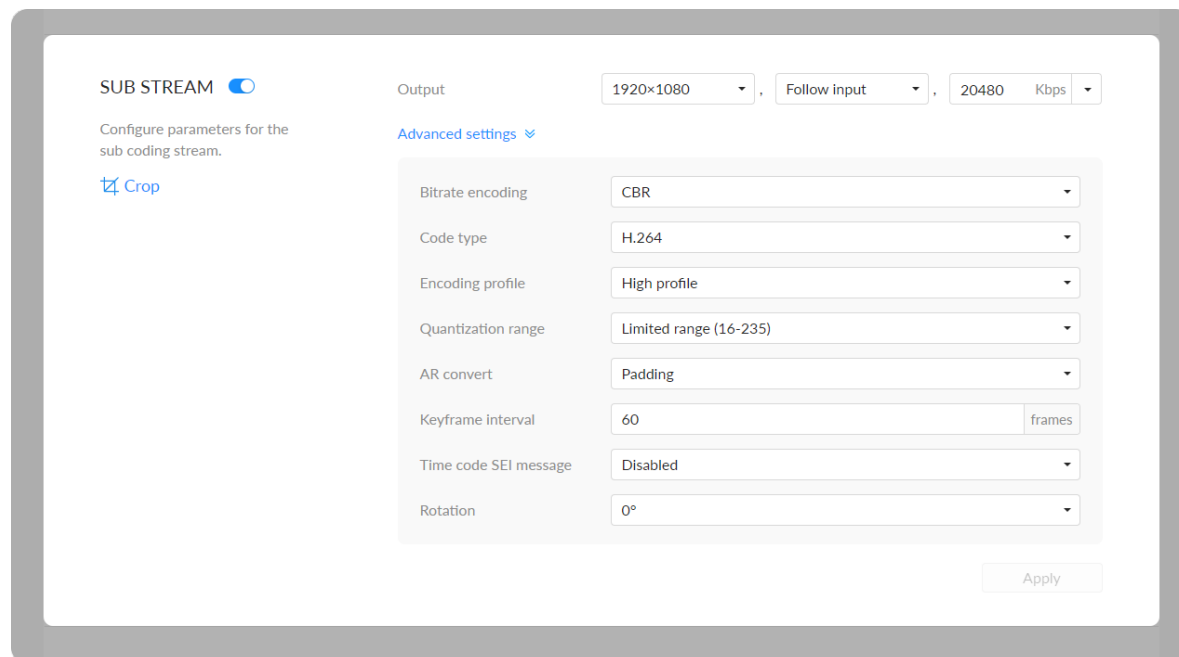
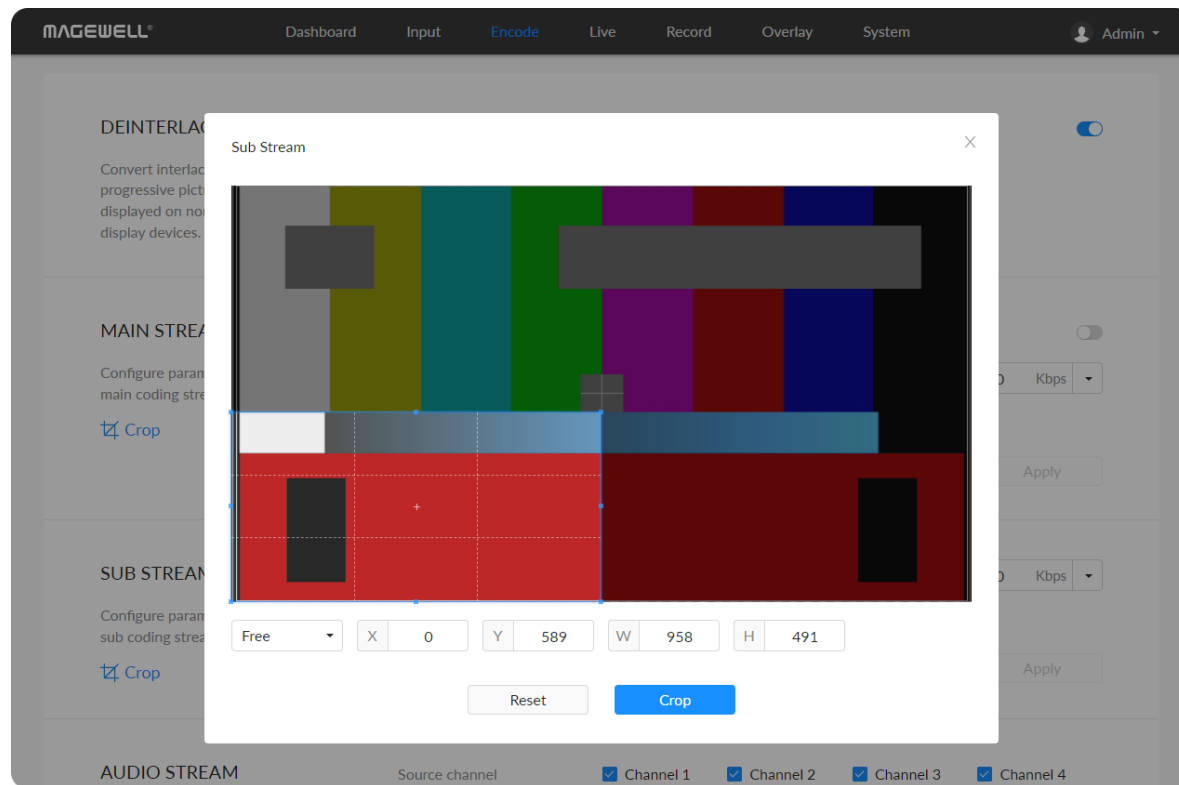

Set SUB STREAM

- The device transmits SUB STREAM data by default, and it can not be switched off when the sub stream data is being recording or streaming.
- **Crop:** click on the  icon, and specify the cropping ratio as Free, 1:1, 3:2, 4:3, 16:9 in the pop-up window. You can drag and drop the crop border to set the crop window. Or specify the the left (x) and top (y) edges of the containing block and the specified width (w) and height (h) of the rectangle. The cropped image will be displayed on the Live, Overlay and LCD screens simultaneously. Click "Reset", the coordinates of the cropping frame will be changed to (0, 0, the resolution WH of the Output configuration).
- **Output:** by default, it is 1280x720, 30fps, 2Mbps. Sub stream outputs at 640x360p30, 3Mbps for NDI[®]|HX3.
- **Bitrate Encoding:** options are CBR (default) and VBR. Live stream at CBR (Constant Bitrate) for bandwidth stability. VBR(Variable Bitrate) files vary the amount of output data per time segment. CBR is the only choice for NDI[®]|HX3. And you need to set quantization parameters for VBR. The quantization parameter controls the amount of compression for every macroblock in a frame. Large values mean that there will be more compression, lower quality, and lower bandwidth. Lower values mean the opposite.
 - **Min QP:** available when **Bitrate Encoding** is VBR. The range of values is 0 to 50. The default value is 4. And we recommend you use the default value and do fine adjustment if needed.
 - **Max QP:** available when **Bitrate Encoding** is VBR. The range of values is 1 to 51. The default value is 40, and it must be larger than the Min QP value. We recommend you use the default value and do fine adjustment

if needed.

- **Code type:** options are H.264 (default) and H.265(HEVC) encoders. H.264 is the only choice for NDI[®]|HX3.
- **Encoding profile:** for H.264 encoder, the profiles can be High (default)/Main profile/Baseline. For H.265 (HEVC), it can be Main profile.
- **Quantization range:** options are Full range(0-255) and Limited range(16-235) (default).
- **AR convert:** options are Ignore, Cropping and Padding (default).
- **Keyframe interval:** options are 15-300 frames. The default value is 60. A less number will result in a larger file size and less buffer time for seeing the first frame. To ensure a clear and smooth live broadcast, it is recommended that the key frame interval be less than or equal to 60 frames. Keyframe interval is fixed at 20 for NDI[®]|HX3.
- **Time code SEI message:** options are off (default), system clock, and embedded. Turn on the switch to get A/V sync between multiple devices which support this SEI message as well.
- **Rotation:** options are 0°(default), 90°, 180°, and 270°. Note that rotation will make overlay not working.

AUDIO STREAM

Configure parameters for the audio streams.

Map source channels with the output channels of stream 1/2/3/4, and specify audio channels for stream 1. Then you can select a specified audio stream for your streaming and recording.

< Audio Stream 1
Audio Stream 2
Audio Stream 3
Audio Stream 4
Audio Stream 5 >

Channel count 4 Channels

LFE

Channel map

Channel 1 map	Source channel 1
Channel 2 map	Source channel 2
Channel 3 map	Source channel 3
Channel 4 map	Source channel 4
Channel 5 map	Source channel 5
Channel 6 map	Source channel 6
Channel 7 map	Source channel 7
Channel 8 map	Source channel 8

AAC 192 Kbps

Apply

© 2023, Nanjing Magewell Electronics Co., Ltd. All rights reserved.
Support | User guide | Legal | Warranty

Set AUDIO

- **Channel count:** for Audio Stream 1, default is 2 channels and it can be 2/4/6/8 channels or follow input. The other audio streams are fixed at 2 audio channels.
- **LFE:** Low Frequency Effect, the switch is off by default. Available when the **Channel count** is greater than 2 channels.
- **Channel map:** specify mapping relationship between the output channel and the source channel selected in **Source channel**.
- **AAC:** from 16 to 256 Kbps, and the default value is 128 Kbps.

Live

The encoder natively supports streaming to YouTube, Facebook, Twitch, as well as self-defined server destinations.

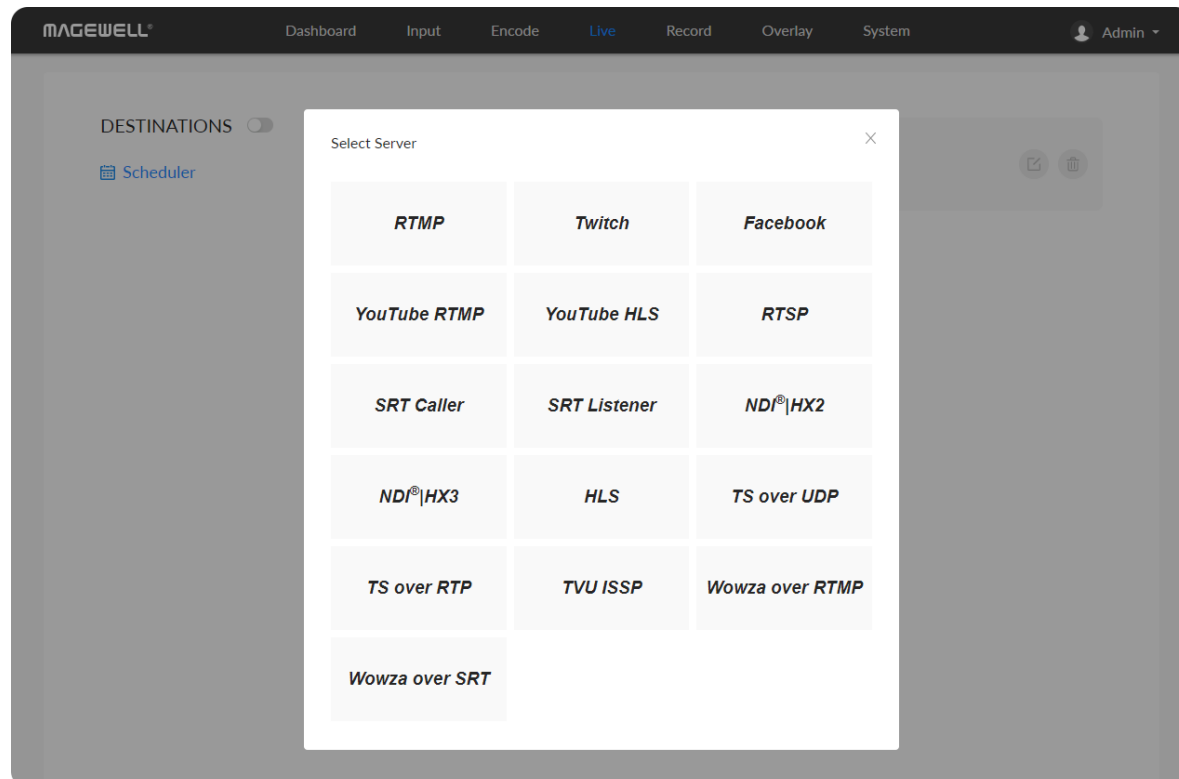
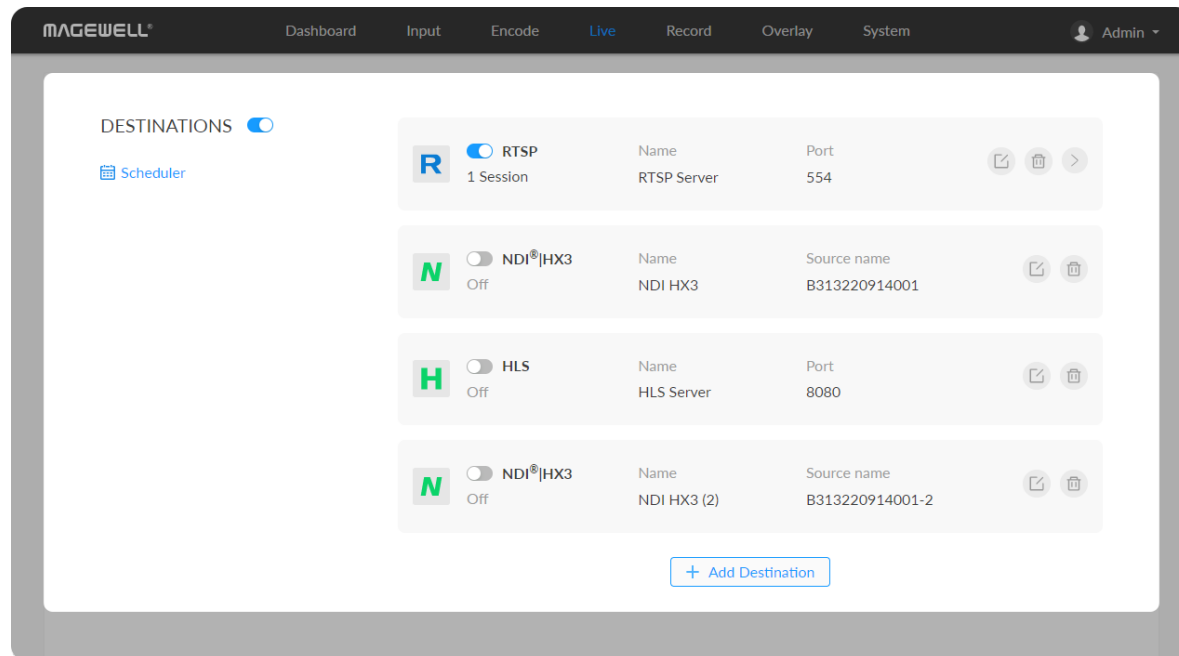

Manage Live Streaming Sessions

You can manually added, modify, or delete any of streaming sessions listed in the **Live** tab.



- Click **Edit** to modify the parameters of the stream.
- Click **Delete** to remove the source from the list.
- Turn on/off the switch  to start/stop streaming.
- Click **Add** and select an RTMP, RTMPS, RTSP, SRT Caller/Listener, NDI®|HX2, NDI®|HX3, HLS, TS over UDP/RTP, or TVU ISSP server to stream to.

Notes



- Supported streaming protocols - RTSP, RTMP, RTMPS, SRT Caller, SRT Listener, NDI®|HX2, NDI®|HX3, HLS, TS over UDP, TS over RTP, and TVU ISSP.
- Allow simultaneous 6 sessions over multiple streaming protocols, containing 1 session of HLS, RTSP, or 2 NDI®|HX2 (if included).
- Exclusive NDI®|HX3 cannot be streamed with other protocols simultaneously and only 1 NDI®|HX3 session can be enabled.
- Specify the main stream or sub stream, even audio stream for each session.

Start/Stop Streaming

After the live broadcast task is added, you can perform any of the following operations.

- To start streaming immediately: you need to turn on the  switch of one session and the **DESTINATIONS** switch.
- To schedule a stream: you need to turn on the  switches of the specified session(s) and scheduler(s).

Use the schedule function for your live stream, which will be triggered, ended, repeated automatically on a chosen day and time.

- To stop streaming:
 - Tap the LCD of the device to switch to live status, tap the live status  bar to make it turn to "NOT LIVE" and end this round of scheduled live.
 - Turn off the **DESTINATIONS** switch  to end this round of scheduled live.
 - Turn off the switch  of the specified live session to stop it permanently.

Edit a Streaming Session

After the live broadcast task is added, in the live broadcast server list, click the  button at the end of the task line, and modify the parameters on the "EDIT SERVER" page.

Delete a streaming Session

After the live broadcast task is added, in the live server list, click the  button at the end of the task line, and confirm the deletion in the pop-up window.

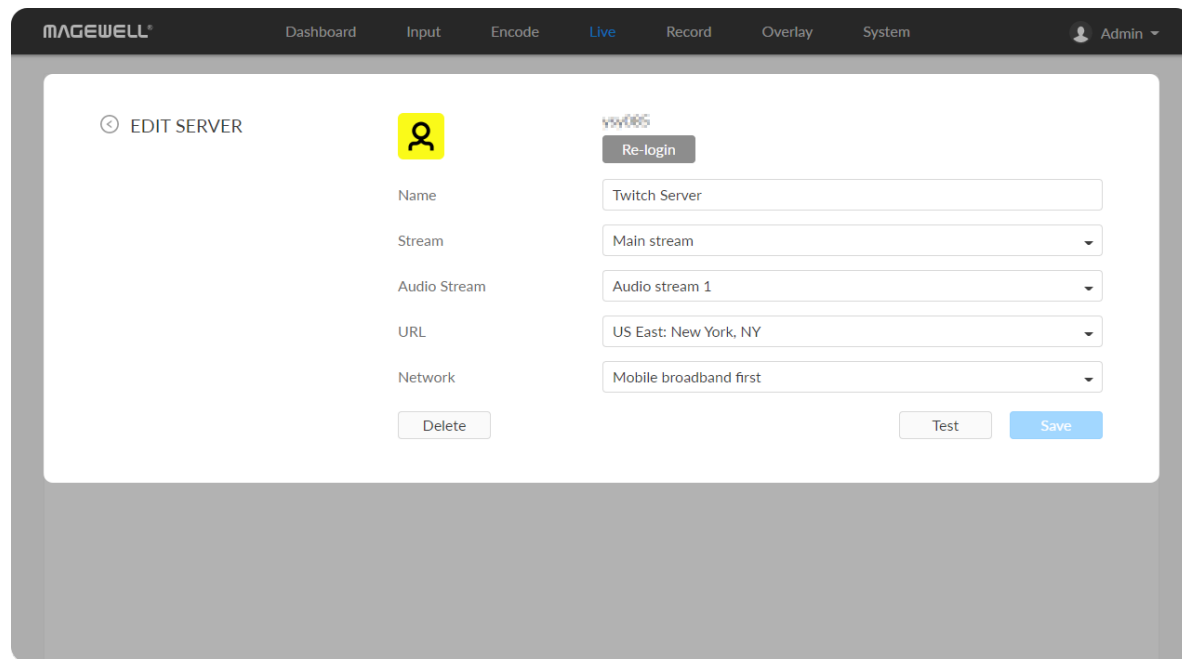



Live Streaming to Twitch

You can stream to Twitch if you have a Twitch account.

⚠ To ensure smooth live streaming experience, connecting to a wired Ethernet network is recommended.

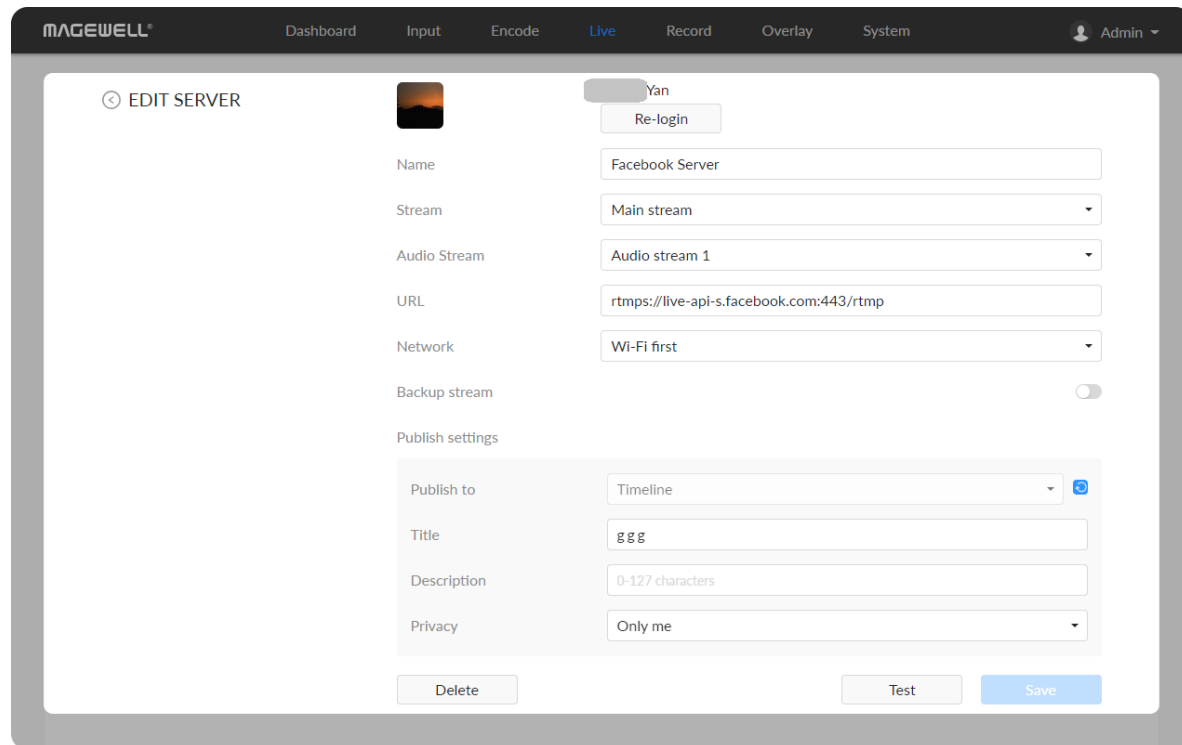
1. Click **+ Add Destination** in the **Live** tab, select **Twitch**, follow the on-screen instructions to log in and select a server.
Your avatar will be displayed after a successful logging-in.
2. Specify a Name for your streaming session, which can be 1 to 30 characters.
3. Choose main or sub stream for streaming, parameters of which can be set in [Encode](#) tab.
4. Choose an audio stream (1 to 8) for streaming, and the default value is Audio stream 1. Audio encoding parameters can be set in [Encode > AUDIO STREAM](#).
5. URL is automatically filled in after successful login, and it is not recommended to change it.
6. Choose the prime network for streaming.
By default, the network connection priority is: Mobile Broadband > Ethernet > Wi-Fi.
The device scans for the available network according to the connection priority and connect to it for streaming. If the current network is disconnected, the unit automatically re-scans according to the priority. Plug a USB modem into your encoder while using mobile network to stream.



7. Click **Test** to check the connection between the server and encoder.
8. When prompted, click **OK**.
9. Go back to **Live** page, turn on  before streaming.

Live Streaming to Facebook Live

You can live broadcast to Facebook if you have a Facebook account.

 To ensure smooth live streaming experience, connecting to a wired Ethernet network is recommended.

1. Click **+ Add Destination** in the **Live** tab, select **Facebook**, enter the **Stream Name**.
2. Click **Log In**. Follow the on-screen instructions to open Facebook, enter the code prompt, and log in.

 Your avatar will be displayed after a successful logging-in.

3. Specify a Name for your streaming session, which can be 1 to 30 characters.
4. Choose main or sub stream for streaming, parameters of which can be set in [Encode](#) tab.
5. Choose an audio stream (1 to 8) for streaming, and the default value is Audio stream 1. Audio encoding parameters can be set in [Encode > AUDIO STREAM](#).
6. Input facebook destination URL.
7. Choose the prime network for streaming.

By default, the network connection priority is: Mobile Broadband > Ethernet > Wi-Fi.

The device scans for the available network according to the connection priority and connect to it for streaming. If the current network is disconnected, the unit automatically re-scans according to the priority. Plug a USB modem into your encoder while using mobile network to stream.

8. (Optional) Turn on the **Backup stream** and specify the **Stream key**.
9. Specify **Publish settings** including **Publish to**, **Title** (0-63 characters), **Description** (0-127 characters), **Privacy** and **Stream ID**.
10. Click **Save**.
11. Click **Test** to check the network connection.
12. After passing the test, click **OK**.
13. (Optional) Click **Delete** to clear the session.
14. Go back to **Live** page, turn on the Facebook live session  to start streaming.

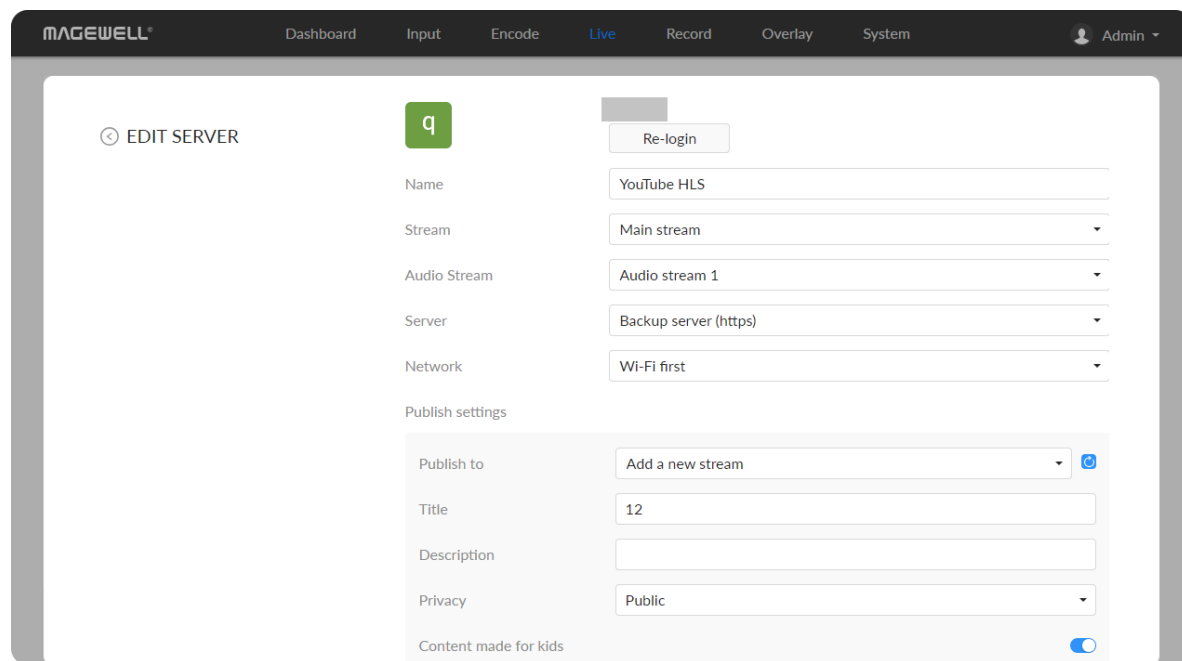
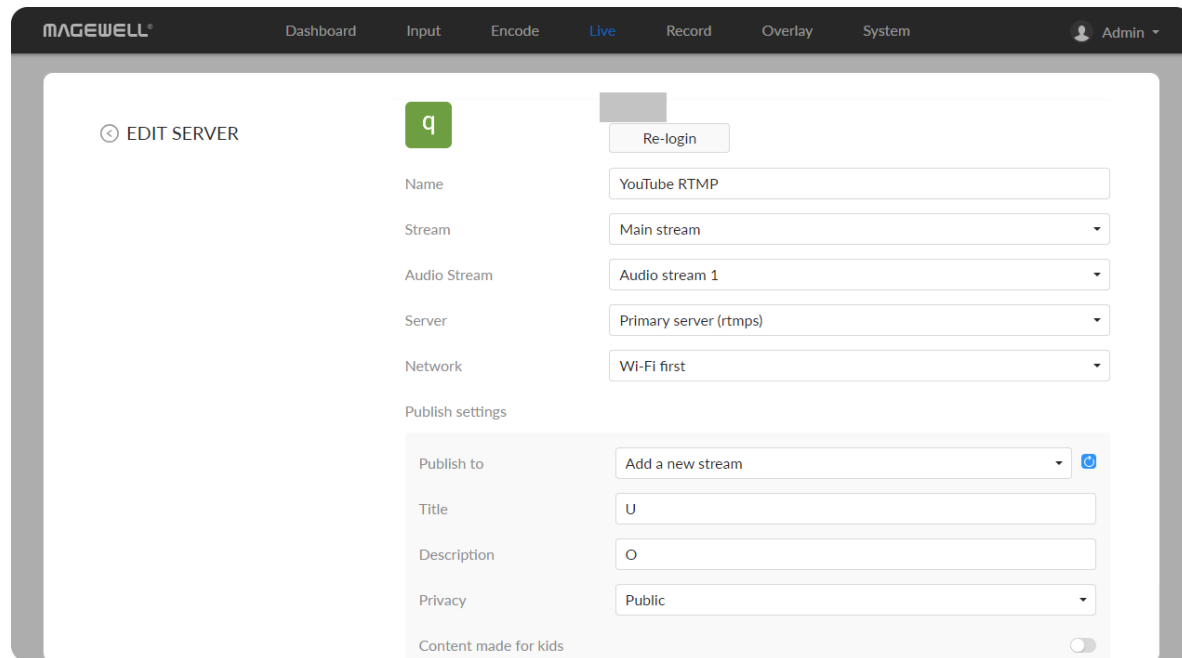

Live Streaming to YouTube

If you need low latency, then YouTube RTMP is the better option. However, if you need adaptive bitrate streaming, then YouTube HLS is the better option. You can stream to YouTube if you have a YouTube account, and you have enabled the Live streaming feature of your channel at least 24 hours before your streaming.

⚠ To ensure smooth live streaming experience, connecting to a wired Ethernet network is recommended.

⚠ To enable the Live streaming feature, refer to [YouTube Help](#).

1. Click **+ Add Destination** in the **Live** tab, select YouTube RTMP or YouTube HLS, enter the stream **Name**, follow the on-screen instructions to log in and select a server.
2. Click **Log In**. Follow the on-screen instructions to open YouTube, enter the code displayed on your device, and log in. Your avatar will be displayed after a successful logging-in.
3. Specify a Name for your streaming session, which can be 1 to 30 characters.
4. Choose main or sub stream for streaming, parameters of which can be set in [Encode](#) tab.
5. Choose an audio stream (1 to 8) for streaming, and the default value is Audio stream 1. Audio encoding parameters can be set in [Encode > AUDIO STREAM](#).

6. Server is automatically filled in after successful login, and it is not recommended to change it.
7. Choose the prime network for streaming.
By default, the network connection priority is: Mobile Broadband > Ethernet > Wi-Fi.
The device scans for the available network according to the connection priority and connect to it for streaming. If the current network is disconnected, the unit automatically re-scans according to the priority. Plug a USB modem into your encoder while using mobile network to stream.
8. Specify **Publish settings** including **Publish to**, **Title** (0-63 characters), **Description** (0-127 characters), **Privacy** and **Stream ID**. Set whether your content is made for kids.
Choose **Add a new stream** and enter title, description and privacy. Then a new live event would be added to your logging-in account automatically. And you can stream to YouTube using streamer without clicking on **go live** in YouTube Studio.
Choose a channel or event. Then **go live** in YouTube studio to ensure a successful live broadcast.
9. Click **Test** to check the connection between the server and encoder.
10. When prompted, click **OK**.
11. Go back to the **Live** page, and turn on  before the added server to start live streaming.

The screenshot shows the 'EDIT SERVER' configuration interface in the MAGEWELL software. The interface includes a navigation bar at the top with tabs for Dashboard, Input, Encode, Live, Record, Overlay, and System, along with an Admin user profile. The main configuration area contains the following fields:

- Name:** Text input field containing 'RTMP Server'.
- Stream:** Dropdown menu set to 'Main stream'.
- Audio Stream:** Dropdown menu set to 'Audio stream 1'.
- URL:** Text input field with a dropdown set to 'rtmp://' and a placeholder 'host[:port]/app/[playpath]'.
- Stream key:** Text input field with a placeholder '0-512 characters'.
- Authentication:** Toggle switch currently turned off.
- Network:** Dropdown menu set to 'Mobile broadband first'.

At the bottom right of the configuration area, there are two buttons: 'Test' and 'Save'.

RTMP/RTMPS

- **Name:** specify a name for current task to facilitate server management, which will be displayed in the server list. The name can be 1~30 character.
- **Stream:** choose to deliver a main or sub stream, which can be customized in [Encode](#) tab.
- **Audio Stream:** options are Audio stream 1 ~ 8, and the default is Audio stream 1. Audio stream parameters can be set in "[Encode > AUDIO STREAM](#)".
- **URL:** enter the RTMP URL address, or an RTMP address you have obtained from the live stream platform. Full address example: `rtmp://192.168.1.136:1935/live`. The port number part `:1935` can be omitted, and the value range is 1 to 65535. If the RTMP address is a domain name, `live` can be omitted. If the RTMP address is an IP address, The part `live` cannot be omitted.
- **Stream key:** enter the stream key obtained from the live stream platform. If none, leave it empty. The key can be string of 0-512 characters.
- **Authentication:** turn on if your live streaming service provider requires. Obtain the User Name and Password from your live streaming service provider.
- **Network:** The device scans for the available network according to the connection priority and connect to it for streaming. If the current network is disconnected, the unit automatically re-scans according to the priority. By default, the network connection priority is: Mobile Broadband > Ethernet > Wi-Fi.
Plug a USB modem into your encoder while using mobile network to stream.

MAGEWELL Dashboard Input Encode **Live** Record Overlay System Admin

EDIT SERVER

Name: RTSP Server

Port: 554

Connections: 4

Main stream:

Main key: mainstream

Sub stream:

Sub key: substream

Audio:

Audio Stream: Audio stream 1

Authentication:

User name: 1-32 characters

Password: 1-32 characters

Delete Save

Main Stream URL: rtsp://<User name>:<Password>@10.10.13.160:554/mainstream
rtsp://<User name>:<Password>@10.20.0.172:554/mainstream

Sub Stream URL: rtsp://<User name>:<Password>@10.10.13.160:554/substream
rtsp://<User name>:<Password>@10.20.0.172:554/substream

- **Test:** check the connection between the server and encoder.
- **Save:** save current configuration.

RTSP

- **Name:** specify a name for current task to facilitate server management, which will be displayed in server list. The name can be 1~30 character.
- **Port:** specify RTSP stream port, the value range is 554 (default), 10000-65535.
- **Connections:** set number of clients for each RTSP stream, 8 clients are supported at most. And you can check the client (session) number at the server list.
- **Main stream:** turn on to push main stream. Specify parameters in [Encode](#) tab. By default, it is on.
- **Main key:** specify stream key for main stream. The main key should be different from sub key.
- **Sub stream:** turn on to push sub stream. Specify parameters in [Encode](#) tab. By default, it is off.
- **Sub key:** specify stream key for sub stream. The sub key should be different from main key.
- **Audio:** turn on to stream audio signal, otherwise audio will not be delivered. The audio signal consists of audio embedded in input signal and LINE IN. By default, it is on.
- **Audio Stream:** options are Audio stream 1 ~ 8, and the default is Audio stream 1. Audio stream parameters can be set in "[Encode > AUDIO](#)"

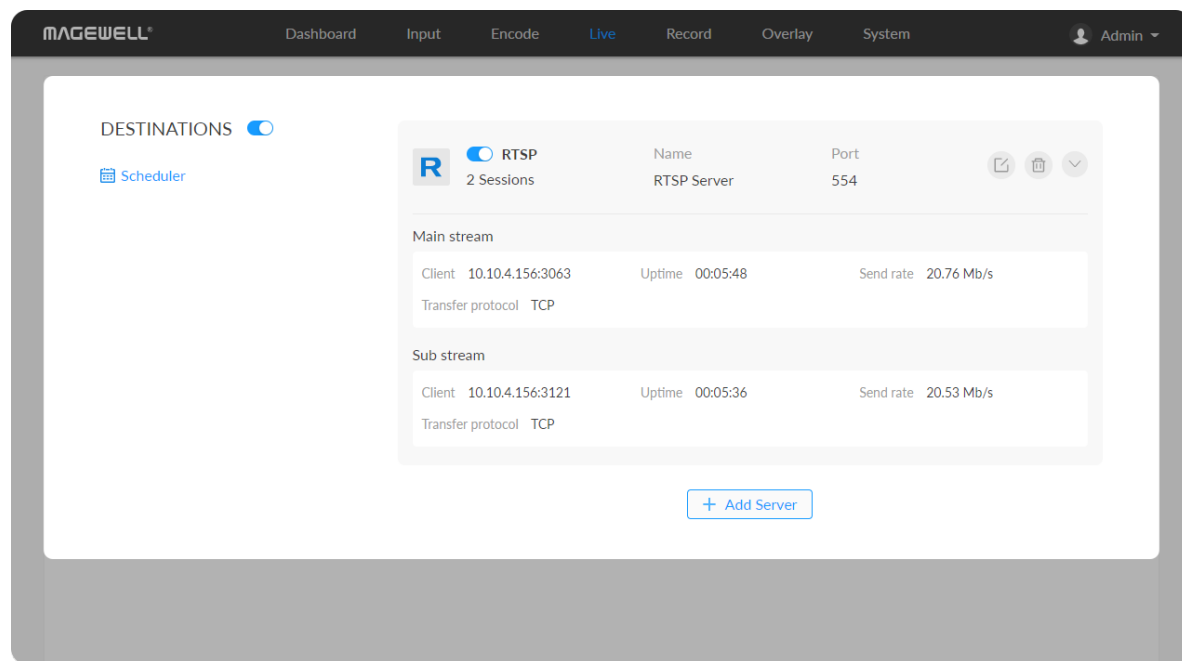

STREAM".

- **Authentication:** turn on if your live streaming service provider requires. Type your user name and password for the streaming service.
- **Save:** save current configuration.
- The encoder can stream 1 RTSP session with other protocol streams.
- After configuration, the stream URLs display at the end of the page. If you have multiple network connections, there would be multiple stream URLs.
- Go back to **Live** tab, you can check the **RTSP** stream sending information by clicking the right arrow at the end of the session in the **DESTINATIONS** list.

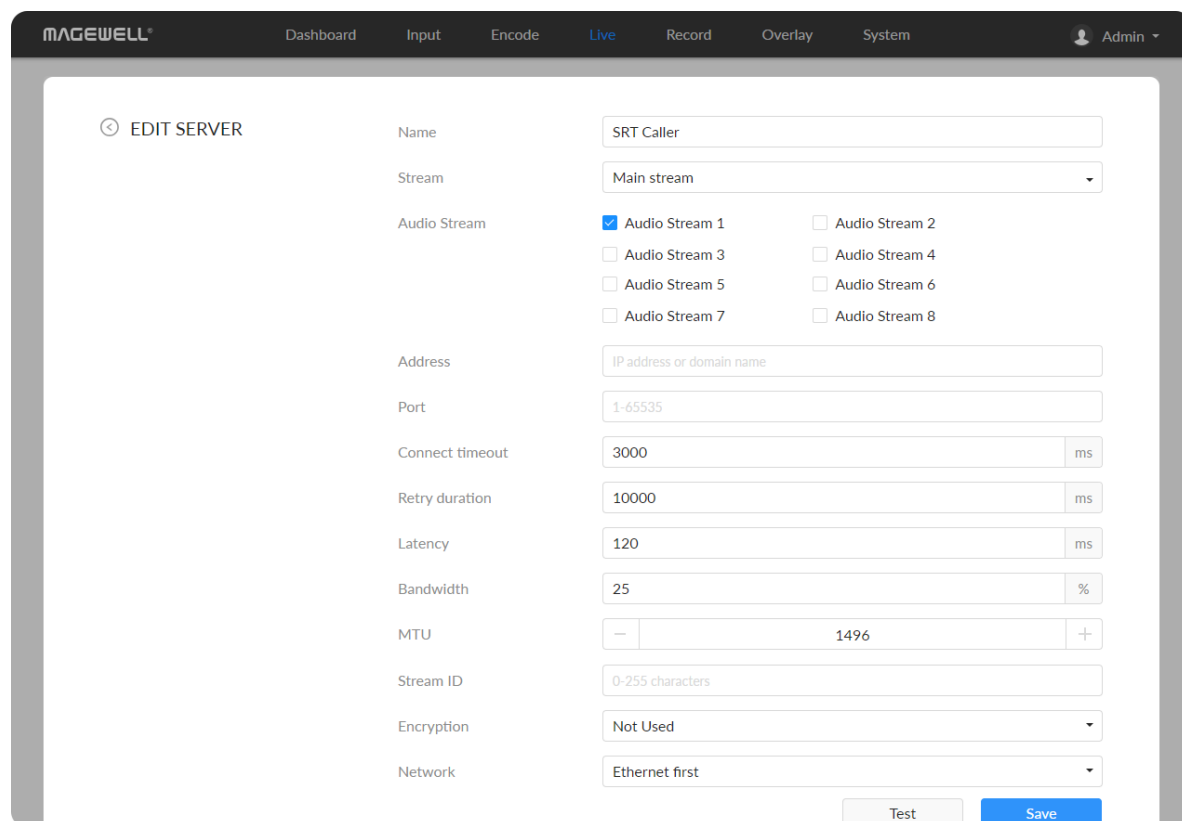

SRT Caller

- **Name:** specify a name for current task to facilitate server management, which will be displayed in server list. The name can be 1~30 character.
- **Stream:** choose to stream main or sub stream, which can be customized in [Encode](#) tab.
- **Audio Stream:** check multiple boxes to choose from Audio stream 1 ~ 8. Each stream will be sent as one track. Audio stream parameters can be set in "[Encode > AUDIO STREAM](#)".
- **Address:** enter the Listener address when **Mode** is set to **Caller**. If the SRT listener and caller are on the same LAN, enter the private IP address of the SRT listener on the LAN. If the SRT listener and caller are in different network environments, enter the public IP address of the SRT listener.
- **Port:** enter the port number specified by the encoder, which ranges from 1

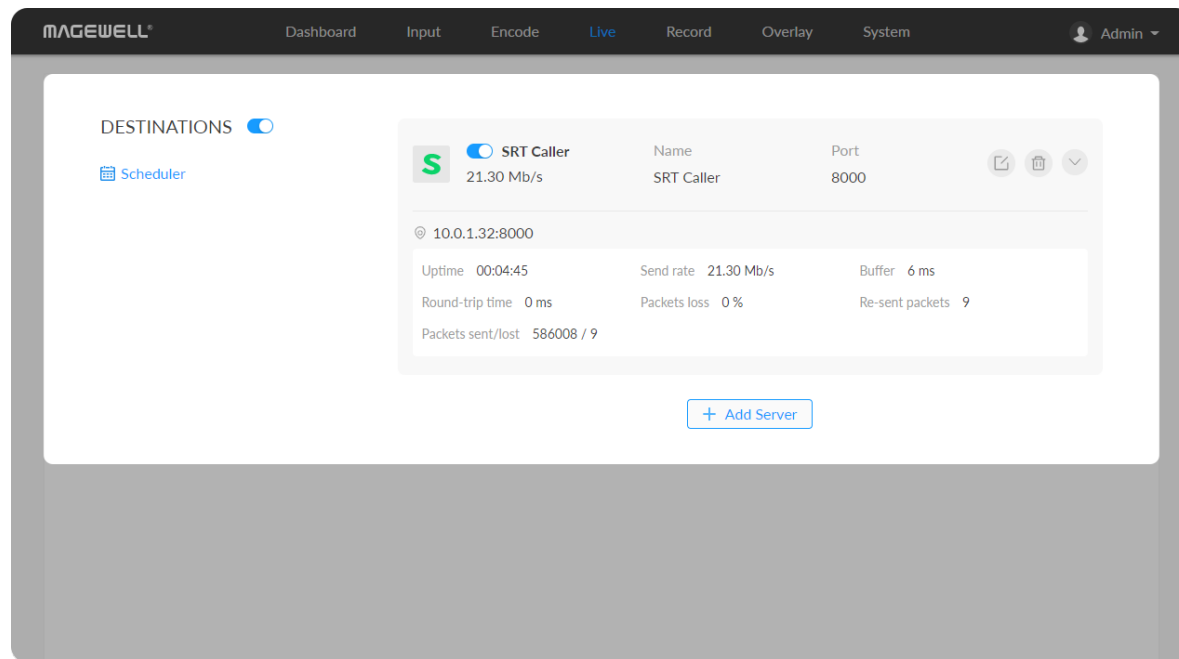

to 65535.

- **Connect timeout:** specify SRT connection timeout in milliseconds, which ranges from 1000 to 30000ms. The default value is 3000.
- **Retry duration:** specify retry duration when SRT SRT connection timeout in milliseconds, which ranges from 0 to 10000. The default value is 10000ms.
- **Latency:** possible values are 30 ~ 8000ms. The default value is 120ms. We recommend that you set the same latency for SRT caller and listener.
- **Bandwidth:** indicate the portion of the total bandwidth of a stream required for the exchange of SRT control and recovery packets. Available values are 5 ~ 100%, and the default value is 25%. A worse network condition requires more bandwidth for overhead to ensure normal transmission.
- **MTU:** specify maximum transmission unit (MTU) in bytes, ranging from 232 to 1500. The default size is 1496.
- **Stream ID:** specify Stream ID of 0 to 256 characters which should be consistent with that of its sender.
- **Encryption:** specify the stream encryption algorithm to ensure the data security, options are not used, AES-128/192/256.
- **Passphrase:** specify stream key of 10 to 79 characters, which is the same as the SRT listener.
- **Network:** The device scans for the available network according to the connection priority and connect to it for streaming. If the current network is disconnected, the unit automatically re-scans according to the priority. By default, the network connection priority is: Mobile Broadband > Ethernet > Wi-Fi.
Plug a USB modem into your encoder while using mobile network to stream.

- **Test:** check the connection between the server and encoder.
- **Save:** save current configuration.
- Go back to **Live** tab, you can check the **SRT Caller** stream sending information by clicking the right arrow at the end of the session in the **DESTINATIONS** list.

The screenshot shows the 'EDIT SERVER' configuration page for an SRT Listener. The settings are as follows:

- Name:** SRT Listener (2)
- Stream:** Main stream
- Audio Stream:** Audio Stream 1 (checked), Audio Stream 2, Audio Stream 3, Audio Stream 4, Audio Stream 5, Audio Stream 6, Audio Stream 7, Audio Stream 8
- Port:** 8000
- Latency:** 120 ms
- Bandwidth:** 25 %
- MTU:** 1496
- Connections:** 1
- Encryption:** Not Used

At the bottom right, there is a 'Save' button and the FFmpeg URL: `srt://10.10.15.204:8000` and `srt://10.20.0.46:8000`.

SRT Listener

- **Name:** specify a name for current task to facilitate server management, which will be displayed in server list. The name can be 1~30 character.
- **Stream:** choose to stream main or sub stream, which can be customized in [Encode](#) tab.
- **Audio Stream:** check multiple boxes to choose from Audio stream 1 ~ 8. Each stream will be sent as one track. Audio stream parameters can be set in "[Encode > AUDIO STREAM](#)".
- **Port:** specify the service port of the encoder, ranging from 8000, and 10000 to 65535. The default value is 8000.
- **Latency:** options are 30 ~ 8000ms and the default value is 120ms. We recommend that you set the same latency for SRT caller and listener.
- **Bandwidth:** indicate the portion of the total bandwidth of a stream required for the exchange of SRT control and recovered packets. Available values are 5 ~ 100% and the default value is 25%. A worse network condition requires more bandwidth for overhead to ensure normal transmission.
- **MTU:** specify maximum transmission unit (MTU) in bytes, ranging from 232 to 1500. The default size is 1496.

- **Connections:** 8 connections at most.
- **Encryption:** specify encryption algorithm for stream data security. Options are not used (default), AES-128/192/256.
- **Passphrase:** specify stream key of 10 to 79 characters, which is the same as the SRT caller.
- **Save:** save current configuration.
- The encoder can stream up to 6 SRT sessions simultaneously, containing one SRT Listener session at most.
- After configuration, the play URL and passphrase are shown in the page below.
- After configuration, the stream URLs display at the end of the page. If you have multiple network connections, there would be multiple stream URLs.
- Go back to **Live** tab, you can check the **SRT Listener** stream sending information by clicking the right arrow at the end of the session in the **DESTINATIONS** list.

The screenshot shows the 'EDIT SERVER' configuration page in the MAGEWELL interface. The page is organized into several sections:

- Name:** A text input field containing 'NDI HX2'.
- Program stream:** A dropdown menu set to 'Main stream'.
- Preview stream:** A dropdown menu set to 'Sub stream'. Below it, a red warning message states: 'The video dimensions (width and height) should be both within 640 pixels.'
- Audio Stream:** A dropdown menu set to 'Audio stream 1'.
- Source video:** A section containing:
 - Machine name:** Text input field with 'Ultra Encode'.
 - Group name:** Text input field with 'public'.
 - Source name:** Text input field with '#serial-no#-3'. Below it, a note says: '#serial-no# indicates the serial number of the device. The current source name is: B313220914001-3'.
- Transport Mode:** A dropdown menu set to 'TCP (Uni-connection)'.
- Discovery Server:** A toggle switch that is turned on.
- Server IP:** An empty text input field.
- Fallover:** A toggle switch that is turned on.
- Source name and IP address:** A table-like structure showing 'N/A' for both, with a 'Change...' button next to the source name.
- Receiver control:** A section with a 'Web control' toggle switch that is turned on.

A blue 'Save' button is located at the bottom right of the configuration area.

NDI

NDI[®]|HX2 and NDI[®]|HX3 are supported.

- **Name:** specify a name for current task to facilitate server management, which will be displayed in server list. The name can be 1~30 character.
- **Program stream:** Options are Main stream, Sub stream, and full black video stream (640x360@30FPS).
- **Preview stream:** Options are Main stream, Sub stream, and full black video stream (640x360@30FPS). Both width and height of the stream resolution must be no greater than 640.
- **Audio Stream:** options are Audio stream 1 ~ 8, and the default is Audio stream 1. Audio stream parameters can be set in "[Encode > AUDIO STREAM](#)".
- **Source Video**

- **Machine name**

It is case-insensitive, and should be a combination of A to Z, a to z, 0 to 9 and special characters like _-#().

By default, it is Ultra Encode.

- **Group name**

Specify the **Group name** which the source belongs to. It is case-insensitive, and should be a combination of A to Z, a to z, 0 to 9 and special characters like _-. Multiple groups are supported, which should be comma-separated.

By default, it is public.

- **Source name**

By default, it is **#serial-no#**, serial number.

The screenshot shows the 'EDIT SERVER' configuration page in the MAGEWELL interface. The page is organized into several sections:

- General Settings:** Name (NDI HX3), Program stream (Main stream), Preview stream (Sub stream), and Audio Stream (Audio stream 1).
- Source video:** Machine name (Ultra Encode), Group name (public), and Source name (#serial-no#-3). A note indicates that #serial-no# is the device's serial number and the current source name is B313220914001-3.
- Transport Mode:** Set to TCP (Uni-connection).
- Discovery Server:** A toggle switch is turned on, and a Server IP field is present.
- Fallover:** A toggle switch is turned on. Below it, a table shows Source name (N/A) and IP address (N/A), with a 'Change...' button next to the source name.
- Receiver control:** A 'Web control' toggle switch is turned on.

A 'Save' button is located at the bottom right of the configuration area.

- **Transport Mode**
 - **UDP (Unicast)** indicates that the encoder sends a UDP stream directly to the receiver. It is used where lower latency matters. And multiple simultaneous streams will work independently for multiple receivers.
 - **UDP (Multicast)** indicates that the encoder sends the UDP stream to a multicast group. It is used for one-to-many broadcast for lower CPU utilization. Parameters in a multicast configuration include:
 - **Multicast IP** ranges from 224.0.0.0 to 239.255.255.255.
 - **Subnet Mask** can be legitimate value ranging from 255.0.0.0 to 255.255.255.0.
 - **Time To Live** ranges from 1 to 255. The default value is 4.
 - **RUDP (Unicast)** indicates that the encoder sends the reliable UDP stream directly to the receiver.
 - **TCP (Uni-connection)** indicates that the encoder sends the TCP stream directly to the receiver.
 - **TCP (Multi-connection)** indicates that the encoder sends the TCP stream to more than one receiver.
- **Discovery Server:** turn on the switch to auto-detect a source sender in different network segment and ping the sender. And the **Server IP** should be the IP address of the server running discovery server software. By default, the switch is off.
- **Fallover:** turn on to protect your NDI transmission from failure. If the initial source video fails, the backup device begins to provide a service. The initial source will be automatically switched back to after it recovers. This function is disabled by default.

- **Source name** shows the backup NDI channel name.
Click **Change...** and select the failover (backup) video device within the same NDI group as the initial source.
 - **IP Address** shows the IP Address of the backup NDI channel which is automatically obtained after you select the backup NDI source.
- **Receiver Control:** turn on Web control to enable you to open the Web UI by clicking the gear icon in the NDI Studio Monitor application.
 - When streaming NDI[®]|HX2, the encoder would send dual streams simultaneously.
 - When streaming NDI[®]|HX3, the encoder would send the dual streams simultaneously, and sub streams format is fixed as 640x360, 30FPS, 3Mbps. The bit rate type of both main and sub streams are CBR, and the key frame interval both are 20.
 - The encoder can stream 2 NDI[®]|HX2 sessions with other protocol streams.
 - When streaming NDI[®]|HX3 session, no other session can be started simultaneously. 1 NDI[®]|HX3 sessions can be started simultaneously.

MAGEWELL Dashboard Input Encode **Live** Record Overlay System Admin

EDIT SERVER

Name: HLS Server

Stream: Main stream

Stream key: stream

Audio Stream: Audio stream 1

Save

Stream URL: <http://10.10.13.160:8080/hls/stream.m3u8>
<http://10.20.0.172:8080/hls/stream.m3u8>

HLS

- **Name:** specify a name for current task to facilitate server management, which will be displayed in server list. The name can be 1~30 character.
- **stream:** options are main stream, and sub stream. Modify the stream profile in [Encode](#) tab.
- **Stream key:** set key for your chosen stream. The keys of dual streams should be different.
- **Audio Stream:** options are Audio stream 1 ~ 8, and the default is Audio stream 1. Audio stream parameters can be set in "[Encode > AUDIO STREAM](#)".
- **Save:** save current server configuration.
- The encoder can stream 1 HLS session with other protocol streams.
- After configuration, the stream URLs will display at the end of the setting page. If you have multiple network connections, there would be multiple stream URLs.

The screenshot shows the 'EDIT SERVER' configuration page for 'TS over UDP'. The page is divided into several sections:

- Name:** Text input field containing 'TS over UDP'.
- Stream:** Dropdown menu set to 'Main stream'.
- Audio Stream:** Eight checkboxes labeled 'Audio Stream 1' through 'Audio Stream 8'. 'Audio Stream 1' is checked.
- Address:** Text input field with placeholder 'IP address or domain name'.
- Port:** Text input field containing '1-65535'.
- Custom PID:** A toggle switch is turned on.
- PMT PID:** Input field with value '256'.
- Video PID:** Input field with value '257'.
- Audio PID:** Eight numbered input fields (1-8) with values 258, 259, 260, 261, 262, 263, 264, and 265 respectively.
- PCR PID:** Input field with value '45'.
- Network:** Dropdown menu set to 'Ethernet first'.
- Save:** A blue button at the bottom right.

TS over UDP/RTP

- **Name:** specify a name for current task to facilitate server management, which will be displayed in server list. The name can be 1~30 character.
- **Stream:** options are main stream and sub stream, which can be customized in [Encode](#) tab.
- **Audio Stream:** options are Audio stream 1 ~ 8, and the default is Audio stream 1. Audio stream parameters can be set in "[Encode > AUDIO STREAM](#)".
- **Address:** specify the destination address.
- **Port:** specify the stream port. The value ranges from 1 to 65535.
- **Custom PID:** PID stands for packet ID. Toggle it on to set the PIDs. PMT PID (program map table) should be different from Video PID, Audio PID and PCR (program clock reference) PID.
 - PMT PID: the default value is 256. The value ranges from 16 to 8190.
 - Video PID: the default value is 257. The value ranges from 16 to 8190.
 - Audio PID: the default value is 258 to 265 for channel 1 to channel 8. The value ranges from 16 to 8190.
 - PCR PID: it is used to sync the audio and video. The default value is 45. The value ranges from 16 to 8190.
- **Network:** The device scans for the available network according to the connection priority and connect to it for streaming. If the current network is disconnected, the unit automatically re-scans according to the priority. By default, the network connection priority is: Mobile Broadband > Ethernet > Wi-Fi.

The screenshot shows the 'EDIT SERVER' configuration page in the MAGEWELL interface. The page is titled 'EDIT SERVER' and has a navigation bar at the top with 'Dashboard', 'Input', 'Encode', 'Live', 'Record', 'Overlay', 'System', and 'Admin'. The main content area is divided into several sections:

- Name:** A text input field containing 'TS over RTP'.
- Stream:** A dropdown menu set to 'Main stream'.
- Audio Stream:** A grid of checkboxes for 'Audio Stream 1' through 'Audio Stream 8'. 'Audio Stream 1' is checked.
- Address:** A text input field with the placeholder 'IP address or domain name'.
- Port:** A text input field containing '1-65535'.
- Custom PID:** A toggle switch that is turned on.
- PMT PID:** A numeric input field with '256' and increment/decrement buttons.
- Video PID:** A numeric input field with '257' and increment/decrement buttons.
- Audio PID:** A grid of 8 numeric input fields, each with a number (1-8) and increment/decrement buttons. The values are 258, 259, 260, 261, 262, 263, 264, and 265.
- PCR PID:** A numeric input field with '45' and increment/decrement buttons.
- Network:** A dropdown menu set to 'Ethernet first'.

A blue 'Save' button is located at the bottom right of the configuration area.

The screenshot shows the 'EDIT SERVER' configuration page in the MAGEWELL interface. The page is titled 'EDIT SERVER' and has a navigation bar at the top with 'Dashboard', 'Input', 'Encode', 'Live', 'Record', 'Overlay', 'System', and 'Admin'. The main content area is divided into several sections:

- Name:** A text input field containing 'TVU ISSP'.
- Stream:** A dropdown menu set to 'Main stream'.
- Audio Stream:** A dropdown menu set to 'Audio stream 1'.
- Port:** A text input field containing '6539'.

A blue 'Save' button is located at the bottom right of the configuration area. Below the 'Save' button, the following text is displayed:

```
Stream URL: issp://10.10.13.160:6539
            issp://10.20.0.172:6539
```

Plug a USB modem into your encoder while using mobile network to stream.

- **Save:** save current configuration.
- You can set TS over UDP/RTP MTU at the System > General > LIVE part.

TVU ISSP

- **Name:** specify a name for current task to facilitate server management, which will be displayed in server list. The value can be 1 to 30 characters, including A-Z, a-z, 0-9, spaces, _-+'[]() and can not begin or end with a space.
- **Stream:** options are main stream and sub stream, which can be customized in [Encode](#) tab.
- **Audio Stream:** options are Audio stream 1 ~ 8, and the default is Audio stream 1. Audio stream parameters can be set in "[Encode > AUDIO STREAM](#)".

The screenshot shows the 'EDIT SERVER' configuration interface in the MAGEWELL web application. The interface includes a navigation bar with tabs for Dashboard, Input, Encode, Live, Record, Overlay, and System. The 'EDIT SERVER' section contains the following fields:

- Name:** Text input field containing 'Wowza over RTMP'.
- Stream:** Dropdown menu with 'Main stream' selected.
- Audio Stream:** Dropdown menu with 'Audio stream 1' selected.
- Network:** Dropdown menu with 'Ethernet first' selected.
- Token:** Empty text input field.
- Publish settings:** A section containing a 'Publish to' dropdown menu and a 'Save' button.

- **Port:** specify the stream port. The value can be 6539 (default), 10000-65535.
- **Save:** save current configuration.
- The encoder can stream 1 TVU ISSP session with other protocol streams.
- After configuration, the stream URLs display at the end of the page. If you have multiple network connections, there would be multiple stream URLs.

Wowza over RTMP

- **Name:** specify a name for current task to facilitate server management, which will be displayed in server list. The name can be 1~30 character.
- **Stream:** options are main stream and sub stream, which can be customized in [Encode](#) tab.
- **Audio Stream:** options are Audio stream 1 ~ 8, and the default is Audio stream 1. Audio stream parameters can be set in "[Encode > AUDIO STREAM](#)".
- **Network:** The device scans for the available network according to the connection priority and connect to it for streaming. If the current network is disconnected, the unit automatically re-scans according to the priority. By default, the network connection priority is: Mobile Broadband > Ethernet > Wi-Fi.
Plug a USB modem into your encoder while using mobile network to stream.
- **Token:** enter Wowza access token. One token can be used for one RTMP and one RTP session.
- **Publish settings:** specify publish destination.
 - **Publish to:** select a channel or event for your session

PUBLISH TO: select a channel or event for your session.

When choosing **Add a new stream**, you need to enter title, description and privacy. Then a new live event would be added to your logging-in account automatically.

- **Live stream name:** specify the session name.
- **Broadcast location:** specify the Wowza server.
- **Save:** save current configuration.

The screenshot shows the 'EDIT SERVER' configuration page in the MAGEWELL interface. The page is titled 'EDIT SERVER' and features a navigation bar with tabs: Dashboard, Input, Encode, Live, Record, Overlay, System, and Admin. The main content area is divided into two columns. The left column contains a list of configuration items, and the right column contains the corresponding input fields.

Configuration Item	Value
Name	Wowza over SRT
Stream	Main stream
Audio Stream	<input checked="" type="checkbox"/> Audio Stream 1, <input type="checkbox"/> Audio Stream 2, <input type="checkbox"/> Audio Stream 3, <input type="checkbox"/> Audio Stream 4, <input type="checkbox"/> Audio Stream 5, <input type="checkbox"/> Audio Stream 6, <input type="checkbox"/> Audio Stream 7, <input type="checkbox"/> Audio Stream 8
Connect timeout	3000 ms
Retry duration	10000 ms
Latency	120 ms
Bandwidth	25 %
MTU	1496
Encryption	Not Used
Network	Ethernet first
Token	
Publish settings	Publish to: [dropdown menu]

A blue 'Save' button is located at the bottom right of the configuration area.

Wowza over SRT

- **Name:** specify a name for current task to facilitate server management, which will be displayed in server list. The name can be 1~30 character.
- **Stream:** options are main stream and sub stream, which can be customized in [Encode](#) tab.
- **Audio Stream:** options are Audio stream 1 ~ 8, and the default is Audio stream 1. Audio stream parameters can be set in "[Encode > AUDIO STREAM](#)".
- **Connect timeout:** specify SRT connection timeout in milliseconds, which ranges from 1000 to 30000ms. The default value is 3000.
- **Retry duration:** specify retry duration when SRT SRT connection timeout in milliseconds, which ranges from 0 to 10000. The default value is 10000ms.
- **Latency:** possible values are 30 ~ 8000ms. The default value is 120ms. We recommend that you set the same latency for SRT caller and listener.
- **Bandwidth:** indicate the portion of the total bandwidth of a stream required for the exchange of SRT control and recovery packets. Available values are 5 ~ 100%, and the default value is 25%. A worse network condition requires

more bandwidth for overhead to ensure normal transmission.

- **MTU:** specify maximum transmission unit (MTU) in bytes, ranging from 232 to 1500. The default size is 1496.
- **Encryption:** specify the stream encryption algorithm to ensure the data security, options are not used, AES-128/192/256.
- **Passphrase:** specify stream key of 10 to 79 characters, which is the same as the sender.
- **Network:** The device scans for the available network according to the connection priority and connect to it for streaming. If the current network is disconnected, the unit automatically re-scans according to the priority. By default, the network connection priority is: Mobile Broadband > Ethernet > Wi-Fi.
Plug a USB modem into your encoder while using mobile network to stream.
- **Token:** enter Wowza access token. One token can be used for one RTMP and one RTP session.
- **Publish settings:** specify publish destination.
 - **Publish to:** with token authentication, refresh and select a channel or event for your session.
When choosing **Add a new stream**, you need to enter title, description and privacy. Then a new live event would be added to your logging-in account automatically.
 - **Live stream name:** specify the session name.
 - **Broadcast location:** specify the Wowza server.
- **Save:** save current configuration.

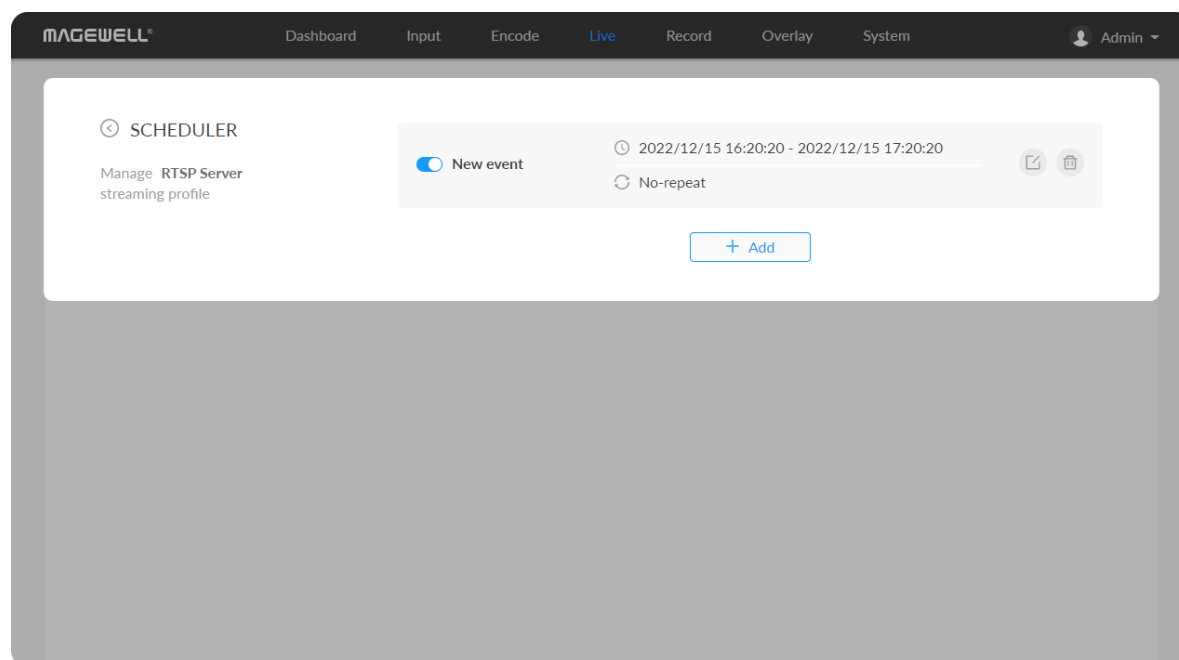
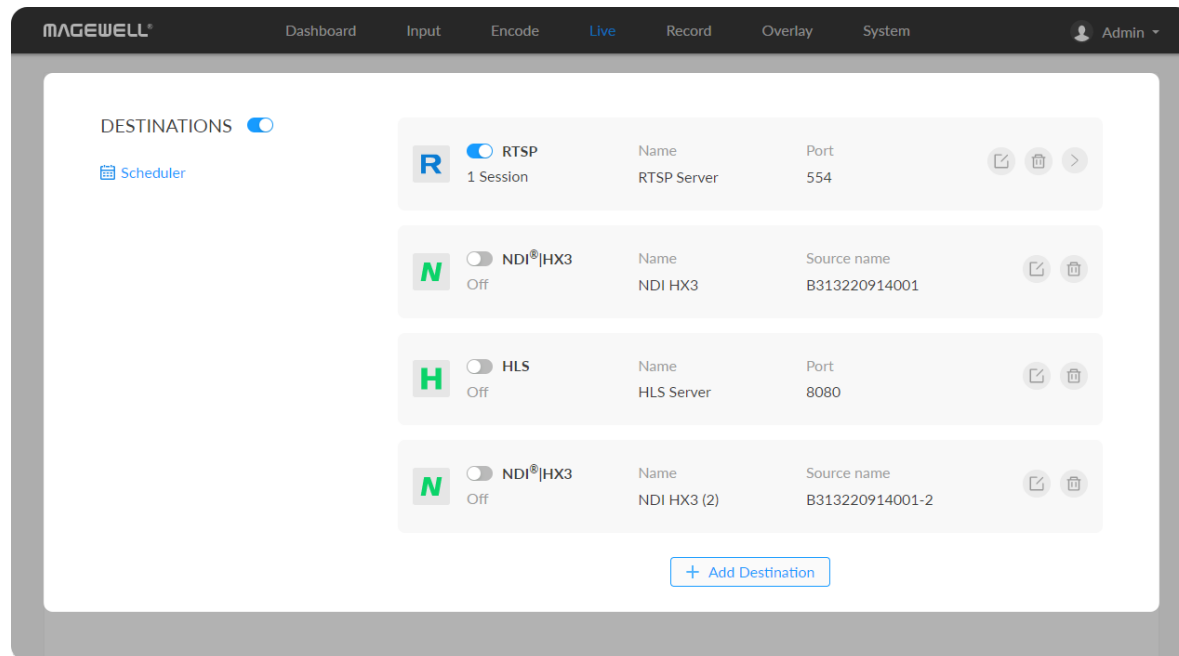

Live Schedule

In everyday terms, a schedule will help you keep on top of other tasks and are less likely to procrastinate, whilst still being able to stream on a regular basis. For a streamer, a schedule will also mean that your viewers, followers, and subscribers will know exactly when you will be live and on which days, which is possibly the biggest reason for creating a schedule and sticking to it. Imagine having no clue when the next episode of your favorite TV show airs. By creating a stream schedule, viewers will know when to expect you and are therefore more likely to tune in. Scheduling your stream is easy with the scheduler we provide. Here's a quick tutorial on how to set it up:

1. Click the  schedule icon.
2. Click **Add** in the window, and specify parameters of the schedule. You can add up to 8 scheduling schemes.
 - **Description:** 1 to 64 characters, including chinese, english, numbers, and special characters, among which one chinese word occupy three characters in length.
 - **Details:** 0 to 64 characters, specifying the scheduling task information
 - **Begin:** Select the start date and specific time of this live broadcast task, or check the **Full day**.
 - **End:** Select the end date and specific time of this live broadcast task, or check the **Full day**.
 - **Repeat event:** Support no-repeat (default), daily, weekly, monthly, yearly.
 - **Daily:** The repeat mode can be repeated every N days, or every workday, and the number of repetitions can be set to

Daily ▾

Every day Every weekday

No end date

After occurrences

End by

Monthly ▾

Repeat day every month

On every month

No end date

After occurrences

End by

- No end date - default,
 - After N occurrences - where **Begin** and **End** indicate the first-repeat,
 - End by specified date YYYY-MM-DD - the session will not repeat on the end day.
- **Weekly:** The repeat mode can be Repeat every 1 week next days: multiple choices are available, and the number of repetitions can be set to
 - No end date - default,
 - After N occurrences - where **Begin** and **End** indicate the first-repeat,
 - End by specified date YYYY-MM-DD - the session will not repeat on the end day.
 - **Monthly:** The repeating pattern may be repeat N days every N month, or on weekday every N month. And you can set the number of repetitions to
 - No end date - default,
 - After N occurrences - where **Begin** and **End** indicate the first-repeat,
 - End by specified date YYYY-MM-DD - the session will not repeat on the end day.
 - **Yearly:** The repeating pattern can be every N day N month, or on N weekday of N month. And you can set the number of repetitions to
 - No end date - default,

Weekly ▼

Repeat every week next days:

Monday Tuesday Wednesday Thursday
 Friday Saturday Sunday

No end date
 After occurrences
 End by

Yearly ▼

Every day month
 On of

No end date
 After occurrences
 End by

- After N occurrences - where **Begin** and **End** indicate the first-repeat,
 - End by specified date YYYY-MM-DD - the session will not repeat on the end day.
3. **Save:** Click to save the current configuration.
 4. Turn on the switch to make your schedule work.

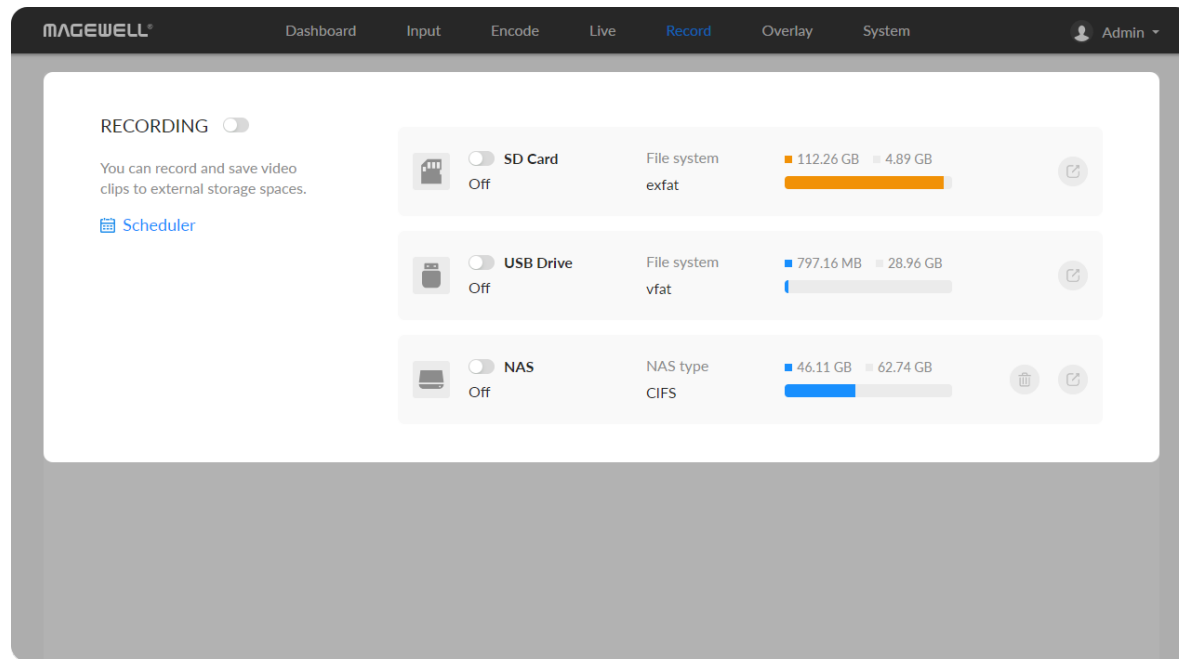

Record



Notes

- The device supports recording and saving videos to SD card, USB drive, and NAS. 2 record tasks can be started simultaneously.
- NAS can be deleted.
- 8 scheduler is provided for all recording tasks.
- The device can automatically start recording by enabling [Auto-recording](#).

Start/Stop Recording

- To start recording immediately: you need to turn on the  switch of one session and the **RECORDING** switch.
- To start recording automatically: you need to turn on the [Auto-recording](#) and the **RECORDING** switch.
- To schedule a recording: you need to turn on the  switches of the specified session(s) and scheduler(s).

Use the schedule function for your live stream, which will be triggered, ended, repeated automatically on a chosen day and time.

- To stop recording immediately:
 - Turn off the **RECORDING** switch to end this round of scheduled recording.
 - Turn off the switch of recording session to stop it permanently.

- Tap on the LCD screen of the device to switch to recording status, tap the status  bar to make it turn to "STBY" and end this round of scheduled recording.

MAGEWELL Dashboard Input Encode Live Record Overlay System Admin

RECORDING

SD CARD Format

Name: 0804-9867
File system: exfat

Used space: 6.75 GB
Free space: 107.51 GB

5%

04 DAY 19 HR
Estimated remaining recording time

PERFORMANCE Done

Write speed (MB/S)
Required speed: 0.27
Your speed: 29.62

VIDEOS All Delete Upload

Configure

VIDEOS All Delete Upload



Configure

VID_37.mp4 2.16 MB	VID_36.mp4 3.04 MB	VID_35_7.mp4 718.13 MB	VID_35_6.mp4 857.36 MB	VID_35_5.mp4 883.80 MB
VID_35_4.mp4 678.90 MB	VID_35_3.mp4 893.51 MB	VID_35_2.mp4 894.43 MB	VID_35.mp4 895.46 MB	VID_34.mp4 22.44 MB
VID_33.mp4 34.58 MB	VID_32.mp4 51.73 MB	VID_31.mp4 34.48 MB	VID_30.mp4 34.53 MB	VID_29.mp4 19.98 MB

< 1 2 3 >

Manage SD card

Click and enter **SD Card** tab, then you can check and manage your SD card.

- To check SD card, such as **File system**, **Free space**, and **Estimated remaining recording time**. Check remaining time for normal recording, and total recording time for loop recording.
- To format SD card: click to start **Format**. After formatting, the file system of USB will be changed to exfat.
- To download video clips: move the cursor to a specified clip and click the  icon to download the chosen one.
- To choose a specific video: move the cursor to a video clip and click .
- To delete videos: choose one or more, or all clips to delete.

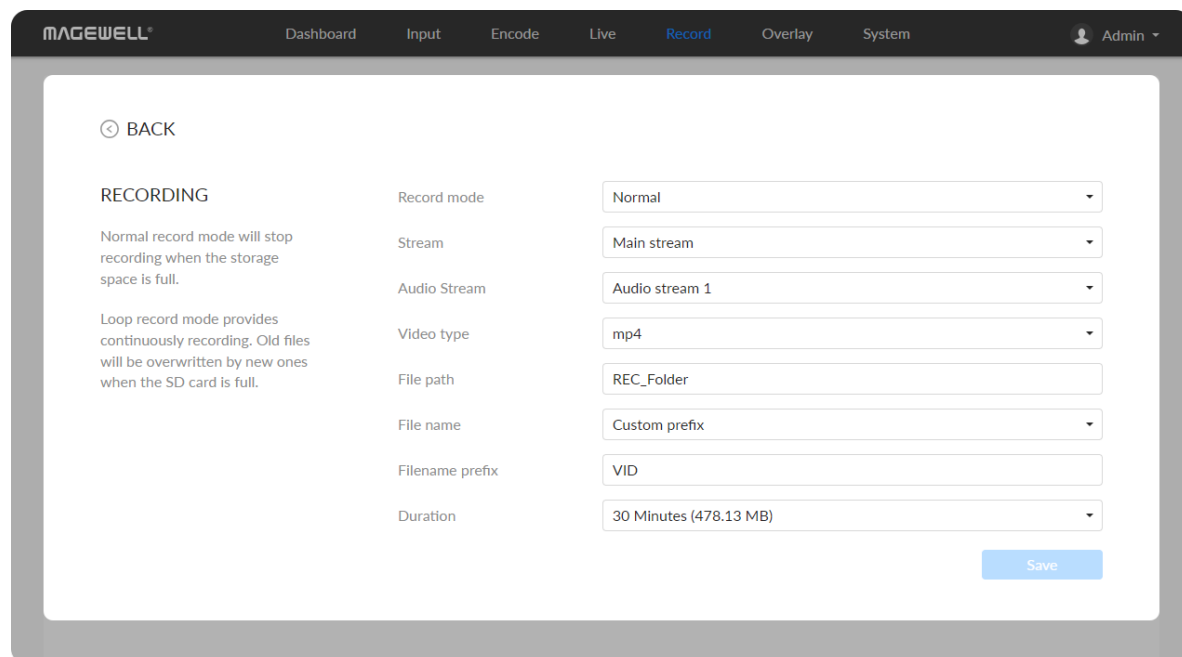

Record to External SD Card

The device supports external SD card in exfat, ntfs, and vfat formats, up to 2T. And a vfat file should be less than 4G. Before recording, please insert the SD Card.

Configure recording parameters

Click  Configure button in the "RECORDING > VIDEOS" section and set recording parameters in the pop-up page.

- **Record mode:** Options are normal (default) and loop. In normal record mode, the encoder will stop recording when the storage space is full. However, loop record mode provides continuously recording which means that old files will be overwritten by new ones when the storage is full.
- **Stream:** Options are main (default) and sub stream.
- **Audio Stream:** options are Audio stream 1 ~ 8, and the default is Audio stream 1. Audio stream parameters can be set in "[Encode > AUDIO STREAM](#)".
- **Video type:** Options are mp4 (default), mov, and ts.
- **File path:** REC_Folder by default, and 1 to 255 characters.
- **File name:** Options are custom prefix (default, from 1 to 32 characters), and creation time.
 - **Filename prefix:** VID by default, 1 to 32 characters.
- **Duration:** from 5 to 240 minutes. That is, a new file is generated for each specified duration. A new file is generated every time the specified duration is recorded. The file size generated by different recording durations is automatically calculated according to the stream format and is for reference only. Duration can be set to **No limit** for normal (Record mode) recording in ts (Video type) format.

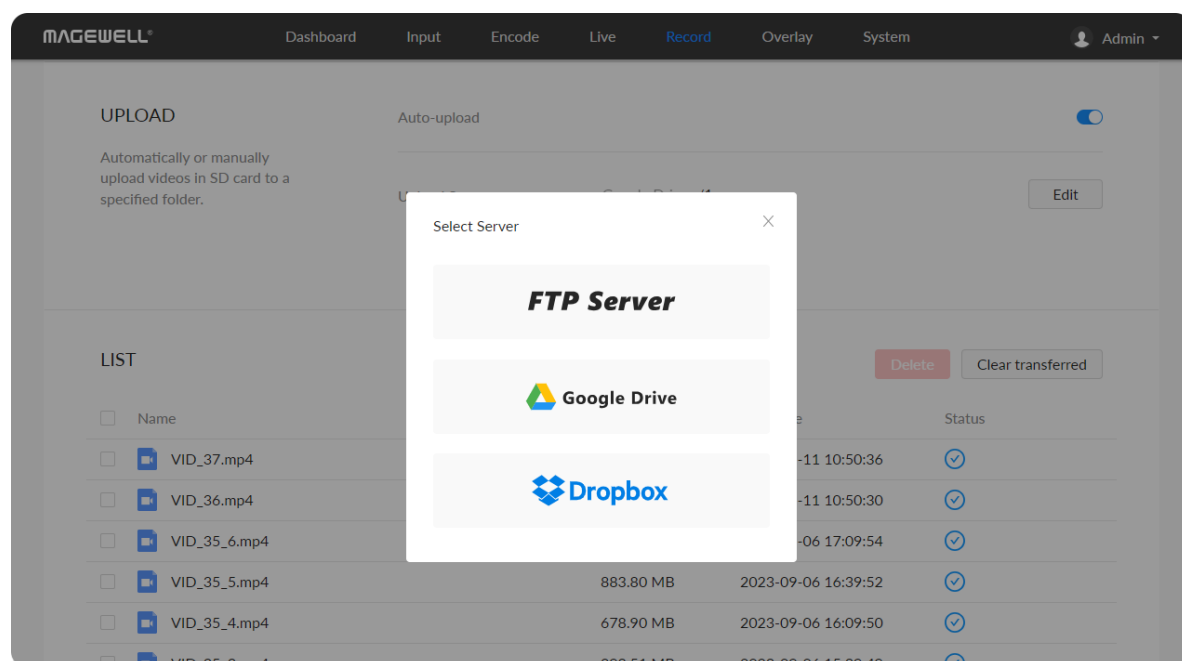
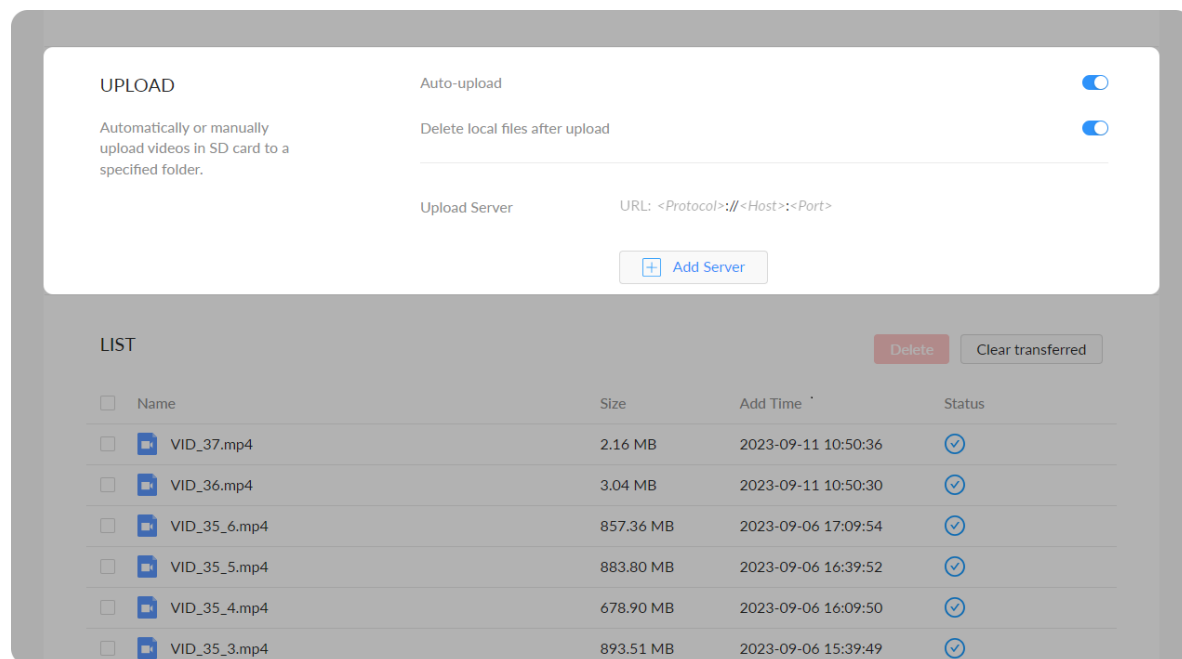

Upload

- **Auto-upload:** off by default. Files recorded to the SD card with the switch on will be automatically uploaded to the specified upload server.
- **Delete local files after upload:** successfully uploaded files will be automatically deleted when turning on the switch. By default, it is off.
- **Upload server:** Click "+Add Server" and choose from FTP Server, Google Drive, Dropbox for uploading.
 - **FTP Server**
 - **Protocol:** options are FTP-File Transfer Protocol, SFTP-SSH File Transfer Protocol.
 - **Host:** IP address or domain name of the host.
 - **Port:** specify port number between 1 and 65535.
 - **Directory:** specify a fold for saving uploaded files between 0 and 63 characters.
 - **Encryption:** options are Only use plain FTP (insecure), Require explicit FTP over TLS and Require implicit FTP over TLS. Available when Protocol is FTP-File Transfer Protocol.
 - **Transfer mode:** Active or Passive.
 - **Authentication:** turn it on if your service provider requires. Type in your user name and password for the streaming service.
 - **Network:** By default, the network connection priority is: Mobile Broadband > Ethernet > Wi-Fi.

- **Test:** check the connection between the server and encoder.
- **Save:** save current configuration.
- **Google Drive**
Follow the prompts to get the verification code, connect the device, and set the network (the default network connection priority is: Mobile Broadband > Ethernet > Wi-Fi).
- **Dropbox**
Follow the prompts to log-into Dropbox, and set the network (the default network connection priority is: Mobile Broadband > Ethernet > Wi-Fi).

LIST Delete Clear transferred

<input type="checkbox"/>	Name	Size	Add Time	Status
<input type="checkbox"/>	VID_37.mp4	2.16 MB	2023-09-11 10:50:36	✓
<input type="checkbox"/>	VID_36.mp4	3.04 MB	2023-09-11 10:50:30	✓
<input type="checkbox"/>	VID_35_6.mp4	857.36 MB	2023-09-06 17:09:54	✓
<input type="checkbox"/>	VID_35_5.mp4	883.80 MB	2023-09-06 16:39:52	✓
<input type="checkbox"/>	VID_35_4.mp4	678.90 MB	2023-09-06 16:09:50	✓
<input type="checkbox"/>	VID_35_3.mp4	893.51 MB	2023-09-06 15:39:49	✓
<input type="checkbox"/>	VID_35_2.mp4	894.43 MB	2023-09-06 15:09:47	✓
<input type="checkbox"/>	VID_35.mp4	895.46 MB	2023-09-06 14:39:45	✓
<input type="checkbox"/>	VID_34.mp4	22.44 MB	2023-09-04 17:07:20	✓
<input type="checkbox"/>	VID_33.mp4	34.58 MB	2023-09-04 17:05:18	✓

< 1 2 >

List

The list shows all the recorded files in SD card. You can check transfer status of them.

- **"Delete"** select one or more files to delete from the list.
- **"Clear transferred"** click on "Clear transferred", the system will automatically delete the files with  transfer status from the list.

MAGEWELL Dashboard Input Encode Live Record Overlay System Admin

RECORDING

USB DRIVE

Name: D99B-FF33
File system: vfat

Used space: 797.16 MB
Free space: 28.96 GB

03 HR 16 MIN
Estimated remaining recording time

Format

PERFORMANCE

Pass
USB drive write speed is fast enough for recording.

Write speed (MB/S)
Required speed: 2.52
Your speed: 7.02

Test

VIDEOS

All

Delete

Configure

MAGEWELL Dashboard Input Encode Live Record Overlay System Admin

RECORDING

USB DRIVE

Name: D99B-FF33
File system: vfat

Used space: 797.16 MB
Free space: 28.96 GB

03 HR 16 MIN
Estimated remaining recording time

Format

PERFORMANCE

Pass
USB drive write speed is fast enough for recording.

Write speed (MB/S)
Required speed: 2.52
Your speed: 7.02

Test

VIDEOS

All

Delete

Configure

Manage USB Flash Drive

Manage the USB and files stored in the **USB Flash Drive** page.

- Check USB Info, such as **File system**, **Free space**, and **Estimated remaining recording time**. Check remaining time for normal recording, and total recording time for loop recording.

We recommend that you use a USB with FAT32/VFAT file system.



- To format USB: click to start **Format**. When prompted, click **YES**. The USB Flash Drive data cannot be recovered after formatting. Please be cautious.

After formatting, the file system of USB will be changed to VFAT.

- To test USB Performance



Click **Test** to start **Performance Test**.

Test whether the write speed of USB flash drive meets the requirements before recording. If the USB fails the test, please change another one, or the recording may stop automatically.

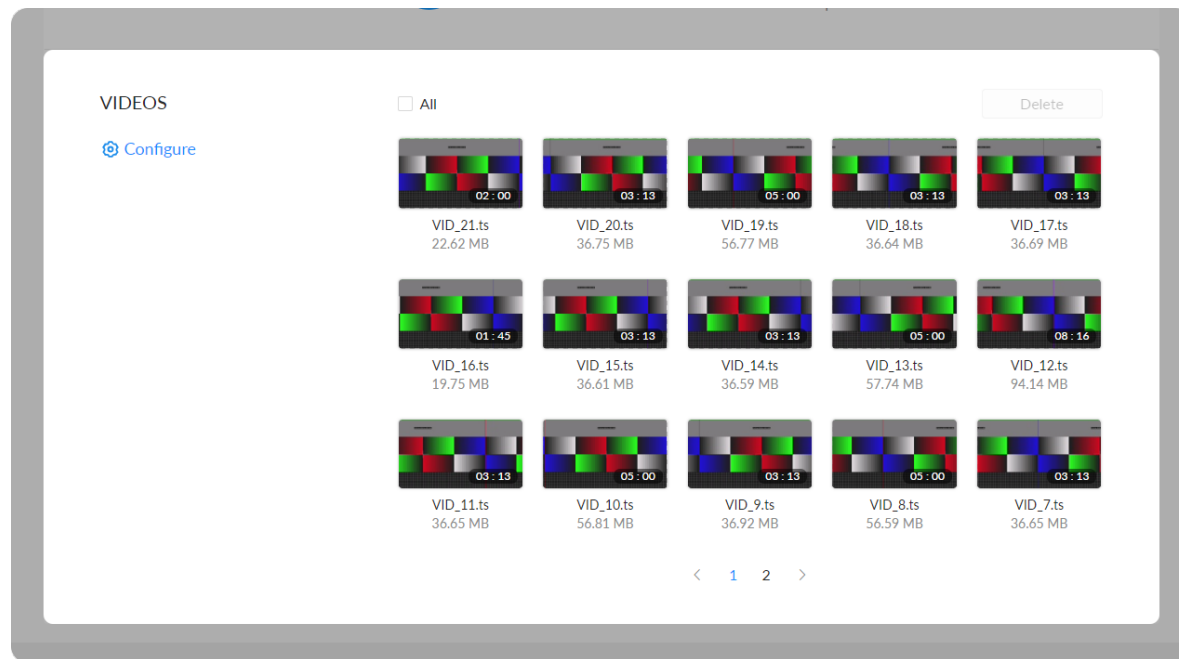
- To download a clip: move the cursor to a specified clip and click the  icon to download the chosen one.
- To choose a specific video: move the cursor to a video and click  to download the clip.
- To delete videos: choose one or more, or all clips to delete.



Manage Video Clips in USB

- To download: move the cursor to a specified clip and click the  icon to download the chosen one.
- To choose a specific video: move the cursor to a video and click  to download the clip.
- To delete videos: choose one or more, or all clips to delete.

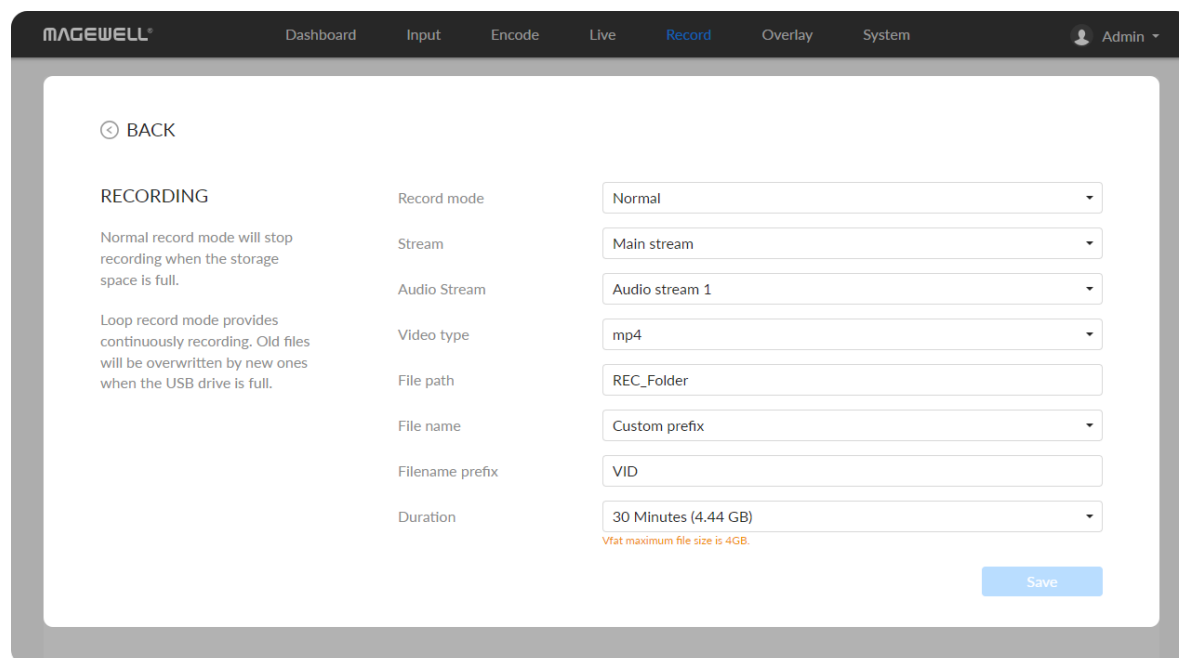

Record to External USB Drive

The device supports external USB flash drive in exfat, ntfs, and vfat formats, up to 2T. And a vfat file should be less than 4G. Before recording, please insert the USB.

Configure recording parameters

Click  Configure button in the "RECORDING > VIDEOS" section and set recording parameters in the pop-up page.

- **Record mode:** Options are normal (default) and loop. In normal record mode, the encoder will stop recording when the storage space is full. However, loop record mode provides continuously recording which means that old files will be overwritten by new ones when the storage is full.
- **Stream:** Options are main (default) and sub stream.
- **Audio Stream:** options are Audio stream 1 ~ 8, and the default is Audio stream 1. Audio stream parameters can be set in "[Encode > AUDIO STREAM](#)".

- **Video type:** Options are mp4 (default), mov, and ts.
- **File path:** REC_Folder by default, and 1 to 255 characters.
- **File name:** Options are custom prefix (default, from 1 to 32 characters), and creation time.
 - **Filename prefix:** VID by default, 1 to 32 characters.
- **Duration:** from 5 to 240 minutes. That is, a new file is generated for each specified duration. A new file is generated every time the specified duration is recorded. The file size generated by different recording durations is automatically calculated according to the stream format and is for reference only. Duration can be set to **No limit** for normal (Record mode) recording in ts (Video type) format.

The screenshot shows the 'CONFIGURE NAS' form in the MAGEWELL web interface. The form is titled 'CONFIGURE NAS' and has a subtitle 'Save recorded files to NAS(Network Attached Storage)'. It contains the following fields and values:

- NAS type: CIFS - Common Internet File System
- User name: Everyone
- Password: 0-63 characters
- Host: 10.10.14.193
- Volume/Mount point: cifs

At the bottom of the form, there are two buttons: 'Clear' and 'Save'.

Record to NAS

Add a NAS

- **NAS type:** options are NFS- Network File System (default) and CIFS- Common Internet File System, which also requires User name and Password.
 - **User name:** 1 to 64 characters,
 - **Password:** 1 to 64 characters,
- **Host:** IP address of NAS.
- **Volume/Mount point:** 1 to 64 characters, and special characters \:"?<>| are not allowed. By using volume mount points, you can graft or mount a target partition onto a folder on another physical disk. You can also exceed the 26-letter limitation for drive letter references. Create a dependency in the mounted volume disk resource that specifies the disk that is hosting the mount point folder. This makes the mounted volume dependent on the host volume, and it makes sure that the host volume comes online.
- **Clear:** restore all parameters to defaults.

MAGEWELL Dashboard Input Encode Live Record Overlay System Admin

RECORDING

NAS
NAS (Network Attached Storage)

Host: 10.10.14.193
NAS type: CIFS

42% Used space: 46.11 GB
Free space: 62.74 GB

07 HR 05 MIN
Estimated remaining recording time

VIDEOS All Delete

[Configure](#)

VID_21.ts 22.62 MB	VID_20.ts 36.75 MB	VID_19.ts 56.77 MB	VID_18.ts 36.64 MB	VID_17.ts 36.69 MB
VID_16.ts 19.75 MB	VID_15.ts 36.61 MB	VID_14.ts 36.59 MB	VID_13.ts 57.74 MB	VID_12.ts 94.14 MB

Manage NAS

Click and enter **NAS** tab, then you can check and manage your NAS storage.

- Check NAS Info, such as NAS type, Free/total space. And check remaining time for normal recording, and total recording time for loop recording.
- To download a clip: move the cursor to a specified clip and click the icon to download the chosen one.
- To choose a specific video: move the cursor to a video and click to download the clip.
- To delete videos: choose one or more, or all clips to delete.

VIDEOS All Delete

[Configure](#)

VID_21.ts 22.62 MB	VID_20.ts 36.75 MB	VID_19.ts 56.77 MB	VID_18.ts 36.64 MB	VID_17.ts 36.69 MB
VID_16.ts 19.75 MB	VID_15.ts 36.61 MB	VID_14.ts 36.59 MB	VID_13.ts 57.74 MB	VID_12.ts 94.14 MB
VID_11.ts 36.65 MB	VID_10.ts 56.81 MB	VID_9.ts 36.92 MB	VID_8.ts 56.59 MB	VID_7.ts 36.65 MB

< 1 2 >

Volume/Mount point: cifs

Clear Save

RECORDING

Normal record mode will stop recording when the storage space is full.

Loop record mode provides continuously recording. Old files will be overwritten by new ones when the NAS is full.

Record mode	Normal
Stream	Main stream
Audio Stream	Audio stream 1
Video type	mp4
File path	REC_Folder
File name	Custom prefix
Filename prefix	VID
Duration	30 Minutes (4.44 GB)

Save

© 2023, Nanjing Magewell Electronics Co., Ltd. All rights reserved. Support | User guide | Legal | Warranty

Configure recording parameters

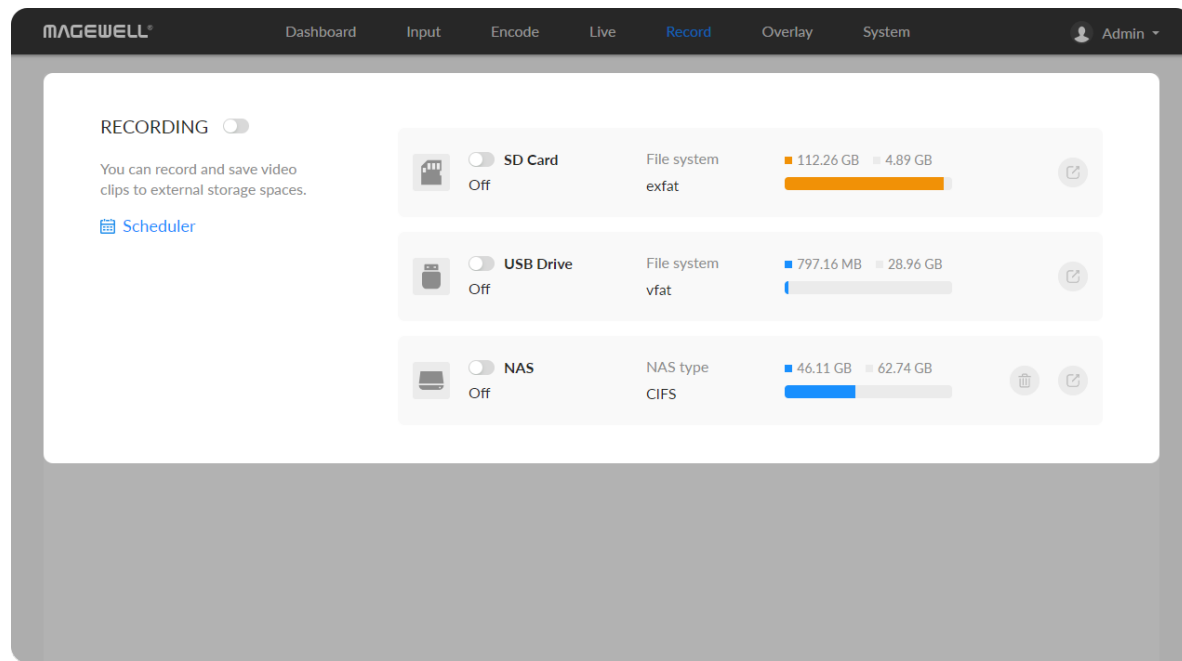

Click  Configure button in the "RECORDING > VIDEOS" section and set recording parameters in the pop-up page.

- **Record mode:** Options are normal (default) and loop. In normal record mode, the encoder will stop recording when the storage space is full. However, loop record mode provides continuously recording which means that old files will be overwritten by new ones when the storage is full.
- **Stream:** Options are main (default) and sub stream.
- **Audio Stream:** options are Audio stream 1 ~ 8, and the default is Audio stream 1. Audio stream parameters can be set in "[Encode > AUDIO STREAM](#)".
- **Video type:** Options are mp4 (default), mov, and ts.
- **File path:** REC_Folder by default, and 1 to 255 characters.
- **File name:** Options are custom prefix (default, from 1 to 32 characters), and creation time.
 - **Filename prefix:** VID by default, 1 to 32 characters.
- **Duration:** from 5 to 240 minutes. That is, a new file is generated for each specified duration. A new file is generated every time the specified duration is recorded. The file size generated by different recording durations is automatically calculated according to the stream format and is for reference only. Duration can be set to **No limit** for normal (Record mode) recording in ts (Video type) format.



Delete the NAS

Go back to **Record** tab, you can delete the NAS in the following ways.

- Click the  delete button behind the nas and confirm your delete in the pop up window.
- Click the  edit button behind the nas and clear all NAS settings.

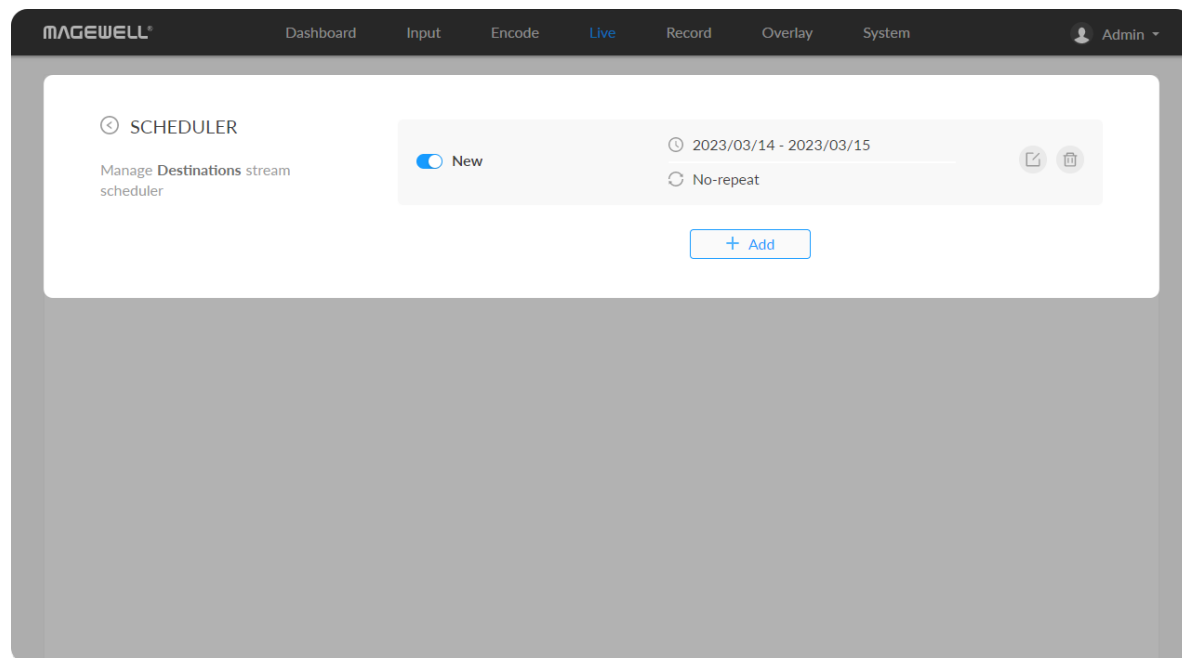

Record Schedule

Set schedule parameters. 8 schedules are supported for recording.

- Click  schedule button.
- Click **Add** in the window, and specify parameters of the schedule. Each session can add up to 8 scheduling schemes.
 - Description:** 1 to 64 characters, including chinese, english, numbers, and special characters, among which one chinese word occupy three characters in length.
 - Details:** 0 to 64 characters, specifying the scheduling task information.
 - Begin:** Select the start date and specific time of this live broadcast task, or check the **Full day**.
 - End:** Select the end date and specific time of this live broadcast task, or check the **Full day**.
 - Repeat event:** Support no-repeat (default), daily, weekly, monthly,

Daily
▼

Every day Every weekday

No end date

After occurrences

End by

Monthly
▼

Repeat day every month

On every month

No end date

After occurrences

End by

yearly.

- **Daily:** The repeat mode can be repeated every N days, or every weekday, and the number of repetitions can be set to
 - No end date - default,
 - After N occurrences - where **Begin** and **End** indicate the first-repeat,
 - End by specified date YYYY-MM-DD - the session will not repeat on the end day.
- **Weekly:** The repeat mode can be Repeat every 1 week next days: multiple choices are available, and the number of repetitions can be set to
 - No end date - default,
 - After N occurrences - where **Begin** and **End** indicate the first-repeat,
 - End by specified date YYYY-MM-DD - the session will not repeat on the end day.
- **Monthly:** The repeating pattern may be repeat N days every N month, or on weekday every N month. And you can set the number of repetitions to
 - No end date - default,
 - After N occurrences - where **Begin** and **End** indicate the first-repeat,
 - End by specified date YYYY-MM-DD - the session will not repeat on the end day.
- **Yearly:** The repeating pattern can be every N day N month, or on N

Weekly ▼

Repeat every week next days:

Monday Tuesday Wednesday Thursday
 Friday Saturday Sunday

No end date

After occurrences

End by

Yearly ▼

Every day month

On of

No end date

After occurrences

End by

weekday of N month. And you can set the number of repetitions to

- No end date - default,
- After N occurrences - where **Begin** and **End** indicate the first-repeat,
- End by specified date YYYY-MM-DD - the session will not repeat on the end day.

3. **Save:** Click to save the current configuration.

4. Turn on the switch to make your schedule work.

Overlay

The overlay function is available when the resolutions of the input signal and the mainstream are no greater than 2048x1080.

The screenshot shows the 'MAIN STREAM' configuration page in the Magewell software. The page has a navigation bar at the top with 'Dashboard', 'Input', 'Encode', 'Live', 'Record', 'Overlay', and 'System'. The 'Overlay' tab is active, and there are sub-tabs for 'Overlays' and 'Gallery'. The main content area is titled 'MAIN STREAM' and contains the text 'Custom overlays for the main stream.' Below this is a preview window showing a video frame with a desert landscape, a timestamp '00:48.650', and a copyright notice 'The copyright of this video is reserved by Magewell'. The preview window has a grid of 12 circular icons for selecting overlays. Below the preview is a 'Display Overlays' toggle switch, which is currently turned on. Underneath, there is a 'Picture' overlay configuration section with a 'Location' field set to '(0, 0)' and a small thumbnail of the desert image. A '+ Add' button is located at the bottom of this section.

The screenshot shows the 'SUB STREAM' configuration page in the Magewell software. The page has the same navigation bar as the main stream page. The main content area is titled 'SUB STREAM' and contains the text 'Custom overlays for the sub stream.' Below this is a preview window showing a video frame with a timestamp '2022-10-17 01:58:36', a timestamp '00:48.317', and a copyright notice 'The copyright of this video is reserved by Magewell'. The preview window has a grid of 12 circular icons for selecting overlays. Below the preview is a 'Display Overlays' toggle switch, which is currently turned on. Underneath, there is a 'Clock' overlay configuration section with a 'Location' field set to '(0, 0)' and a 'Format' field set to 'YYYY-MM-DD hh:mm:ss'. A '+ Add' button is located at the bottom of this section.

Set Overlays for the Main and Sub Streams

Display Overlays is off by default. You can preview thumbnails with enabled overlays after turning it on.

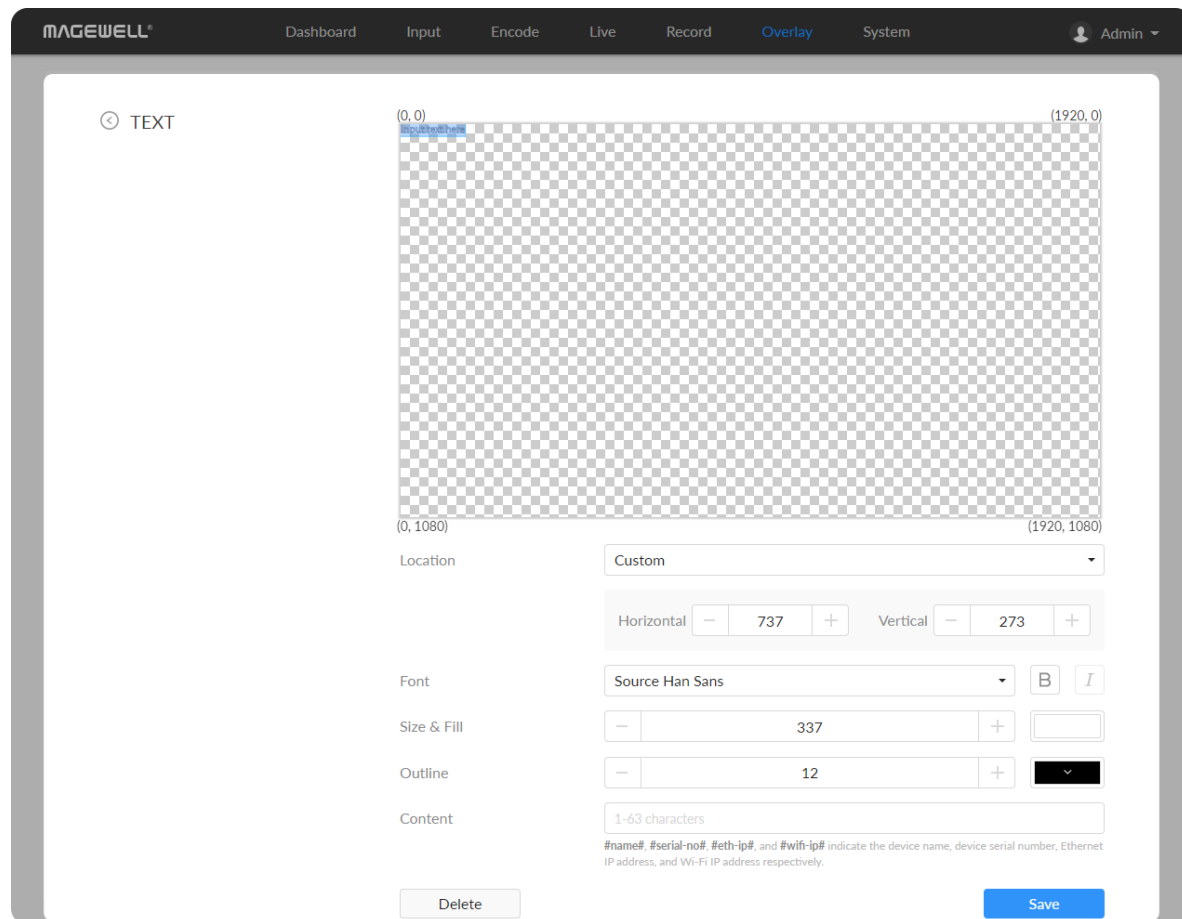

Add Text

- **Location:** options are Custom(default), Top left, Top right, Top center, Bottom left, Bottom right, Bottom center, and Center. Or just drag the item on the 1920x1080 canvas and place it at your desired location.
- **Horizontal:** specify the horizontal coordinates manually when location is Custom.
- **Vertical:** specify the vertical coordinates manually when location is Custom.
- **Font:** options are Source Han Sans (default), and Lato. Bold and Tilt are also provided.
- **Size & Fill:** font size is 26px by default. You can set from 6 to 400px. The default fill color is rgba(255, 255, 255, 1), and you can click the color-picker to custom your desired color.
- **Outline:** the default width of outline is 1px. You can set from 0 to 100px. And the default outline color is rgba(0, 0, 0, 1), and you can click the color-picker to custom your desired color.
- **Content:** 1 to 63 characters are supported to display.
- **Save:** save current configuration.

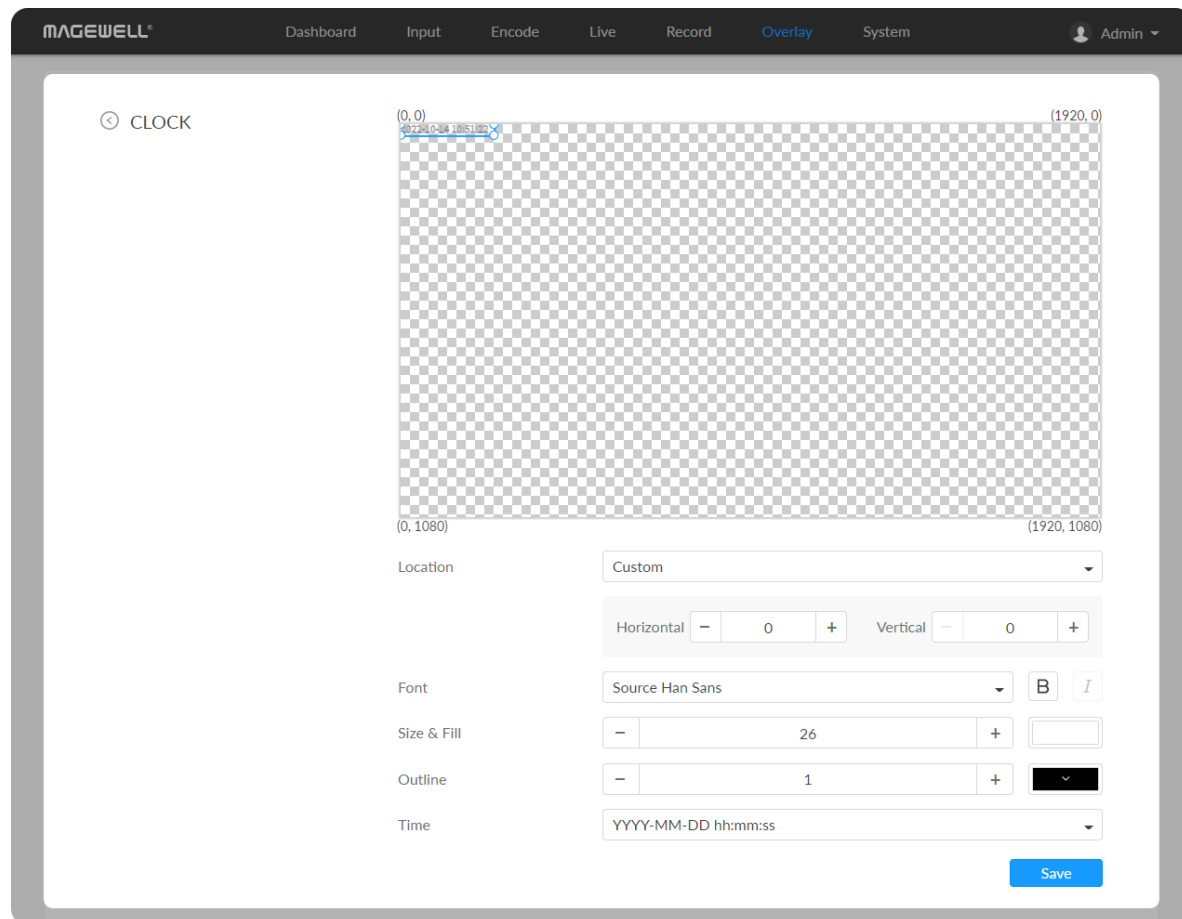

Add Clocks

- **Location:** options are Custom(default), Top left, Top right, Top center, Bottom left, Bottom right, Bottom center, and Center. Or just drag the item on the 1920x1080 canvas and place it at your desired location.
- **Horizontal:** specify the horizontal coordinates manually when location is Custom.
- **Vertical:** specify the vertical coordinates manually when location is Custom.
- **Font:** options are Source Han Sans (default), and Lato. Bold and Tilt are also provided.
- **Size & Fill:** font size is 26px by default. You can set from 6 to 400px. The default fill color is rgba(255, 255, 255, 1), and you can click the color-picker to custom your desired color.
- **Outline:** the default width of outline is 1px. You can set from 0 to 100px. And the default outline color is rgba(0, 0, 0, 1), and you can click the color-picker to custom your desired color.
- **Time:** options are as follows.
 - YYYY-MM-DD hh:mm:ss
 - MM/DD/YYYY hh:mm:ss
 - DD/MM/YYYY hh:mm:ss
 - YYYY-MM-DD
 - MM/DD/YYYY
 - DD/MM/YYYY
 - hh:mm:ss
 - hh:mm

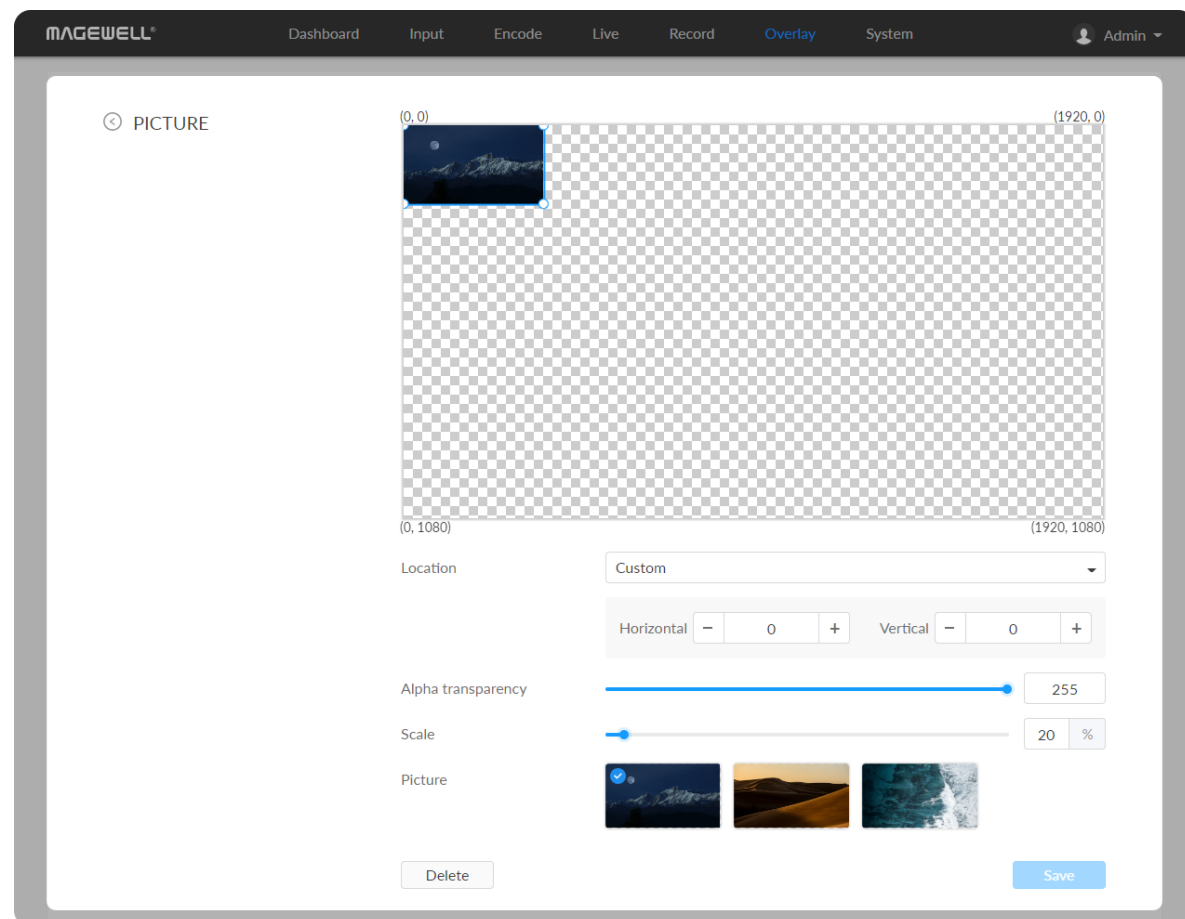

- **Save:** save current configuration.

Add Pictures

- **Location:** options are Custom(default), Top left, Top right, Top center, Bottom left, Bottom right, Bottom center, and Center. Or just drag the item on the 1920x1080 canvas and place it at your desired location.
- **Horizontal:** specify the horizontal coordinates manually when location is Custom.
- **Vertical:** specify the vertical coordinates manually when location is Custom.
- **Alpha transparency:** it can have a value from 0 (0%) to 255 (100%) in opacity.
- **Scale:** resize your picture between 1% to 400%. By default it is 100%.
- **Picture:** choose a picture from Overlay > Gallery. There is no picture by default.
- **Save:** save current configuration.

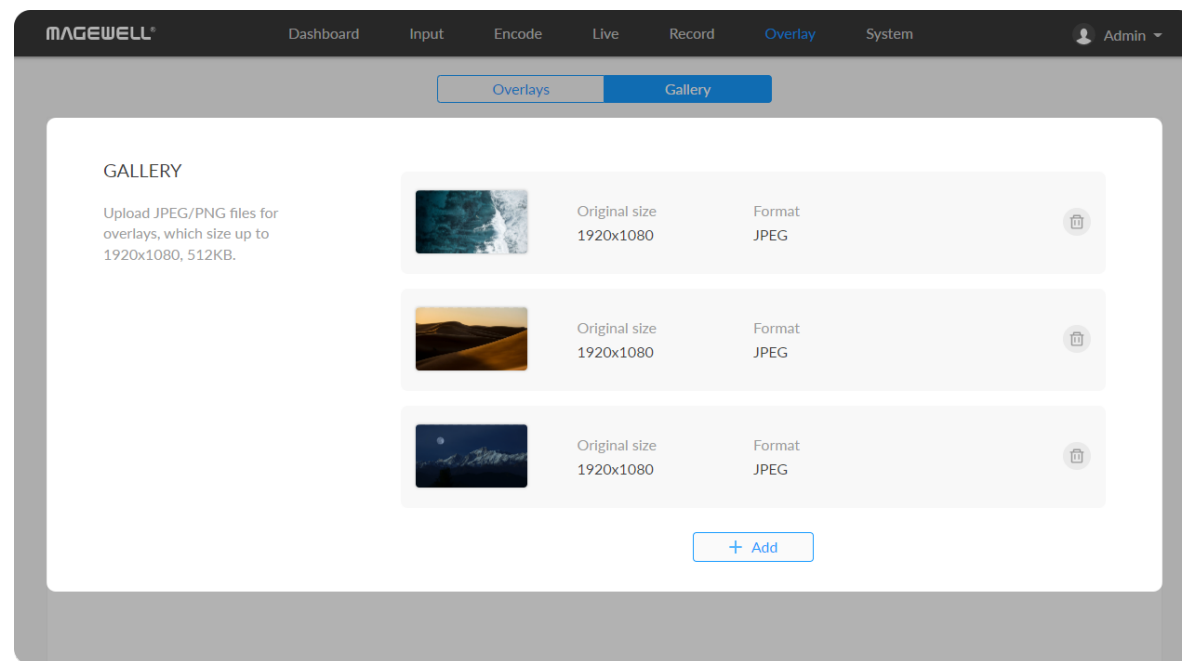

Gallery

- Upload JPEG/PNG files for overlays, up to 1920x1080, 1 M. And you can add 8 pictures at most.
- You can choose the picture in Overlay > Picture after uploading successfully.
- Click delete button  to delete current picture from your device.

General

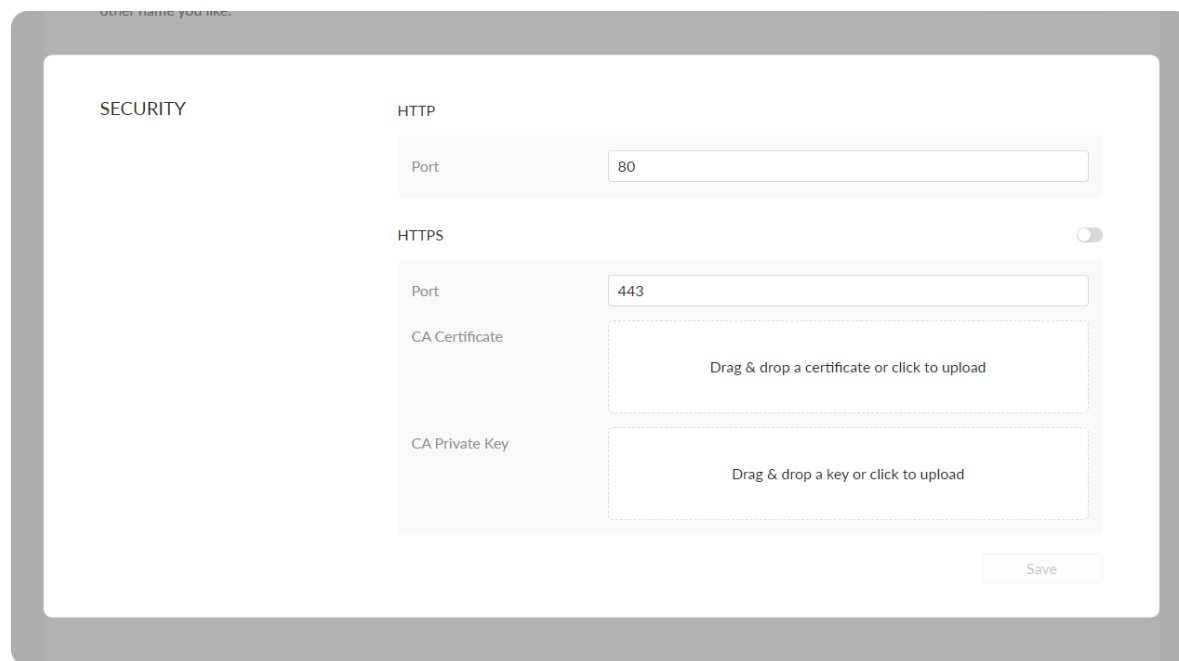
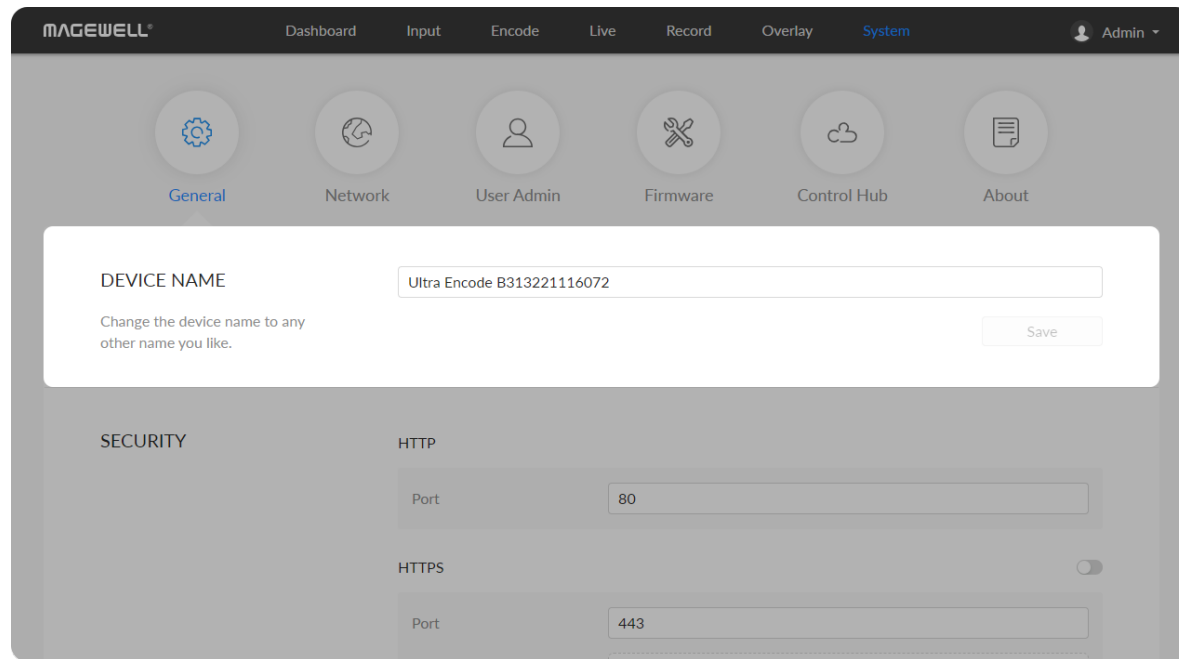

- **DEVICE NAME:** value range is from 1 to 32 characters, including A-Z, a-z, 0-9, space ._- + ' [] () and cannot begin or end with a space.
- **Save:** save current configuration.

Modify SECURITY settings

1. Modify HTTP port.
The default port is 80. Modify the port number ranging from 1 to 65535, based on your network condition, then click **Save**.
2. Secure the Control Hub with HTTPS.
Turn on HTTPS, then specify the port number ranging from 1 to 65535 for HTTPS. The default port is 443.
 - Modify HTTPS port.
The default port is 443. Modify the port number ranging from 1 to 65535, based on your network condition, then click **Save**.
 - Import a CA certificate and private key into Control Hub.

Renew certificates by uploading the new files that you want to, without removing existing ones. Then click **Save**.

3. Re-log into Web UI.

Open your Web browser and type `http://IPaddress:new-port`, or `https://IPaddress` to access the SIGN IN page.

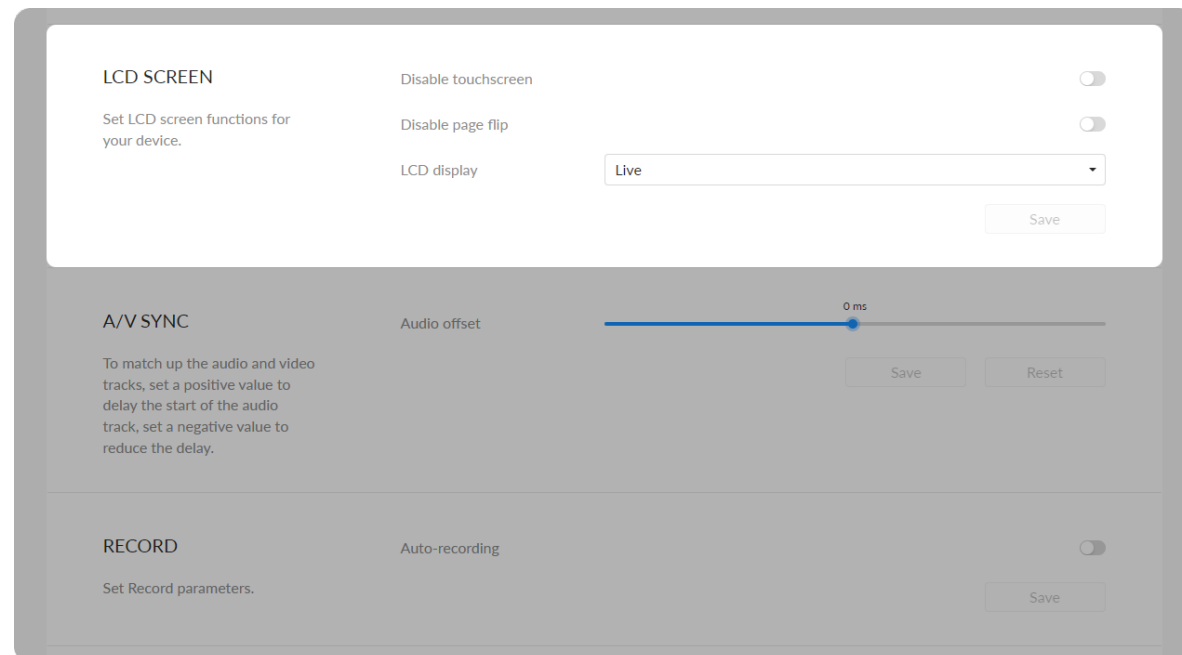

LCD SCREEN

- **Disable touchscreen:** off by default. The LCD touchscreen function will not work after turning it on.
 - **Disable page flip:** off by default. Turning it on, turn **Disable touchscreen** off, and specify the **LCD display** as Live or Record, then you can tap on the LCD screen to start/stop the streaming or recording task.
 - **LCD display:** options are Preview, Live, Record and QR code (Web UI).
- **Save:** Click to save the current configuration.

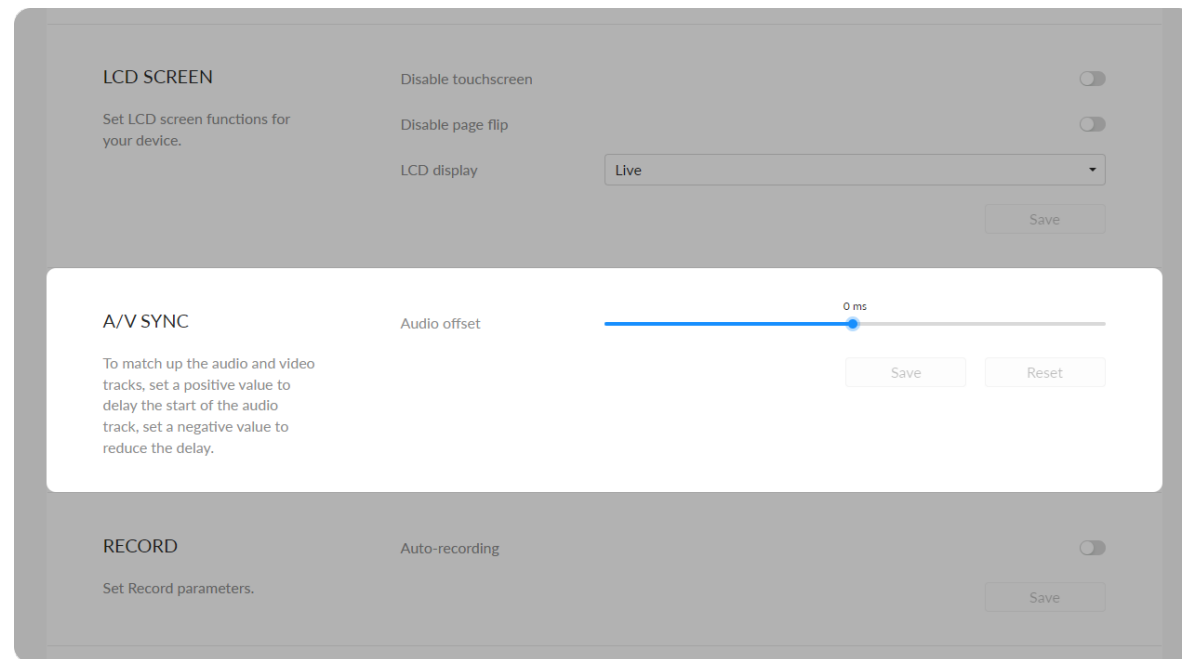

A/V Sync

- **Audio offset** ranges from -200 to 200ms.
To match up the audio and video tracks, set a positive value to delay the start of the audio track, or set a negative value to reduce the delay.
We recommend that you start your live after this configuration.
- **Save:** save current configuration.
- **Reset:** reset parameters to default values.

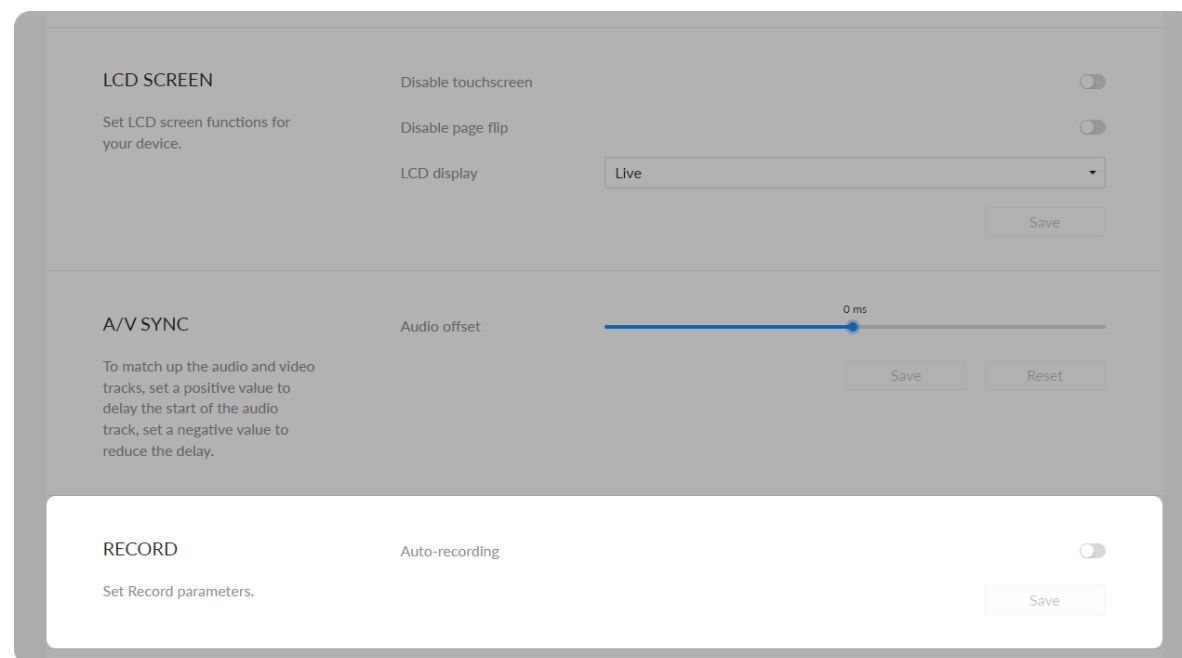

RECORD

- **Auto-recording:** it is off by default. If you turn it on, options are Automatic - signal locked and Automatic - USB drive connected (recommended if you need to record to USB). You need to turn on the specified record task switch in the Record tab at the same time to make the auto-recording function work.
- **Save:** save current configuration.

LIVE
Set Live parameters.

TS Over UDP/RTP

MTU: Save Reset

HLS (push)

Segment count: Save

Segment duration(sec): Save

DATE & TIME
Set proper time for your streamer to live and record.

Time zone: Save

Set time automatically:

Live

TS over UDP/RTP

- **MTU:** specify maximum transmission unit (MTU) in bytes, ranging from 228 to 1500. The default size is 1496.
- **Save:** save current configuration.
- **Reset:** reset parameters to default values.

HLS (push)

Configurations will work on both HLS and Youtube HLS sessions.

- **Segment count:** between 1 and 5.
- **Segment duration(sec):** between 1 and 4. Lower value results in lower latency.
- **Save:** save current configuration.

DATE & TIME
Set proper time for your streamer to live and record.

Time zone: Save

Set time automatically:

NTP server 1:

NTP server 2: Save

RESET
Reset all settings will cause all configurations to return to the default value.

Reset all settings Import settings... Export settings...

REBOOT
Reboot the device

Date & Time

- **Time zone:** specify a time zone for your device.
- **Set time automatically:** turn on **Set Time Automatically**. Then the device's time will be synchronized to the world-time servers depending on the timezone you set. Otherwise, you can set time manually.
- **NTP server 1:** the default server is 0.pool.ntp.org.
- **NTP server 2:** the default server is 1.pool.ntp.org.
- **Save:** save current configuration.

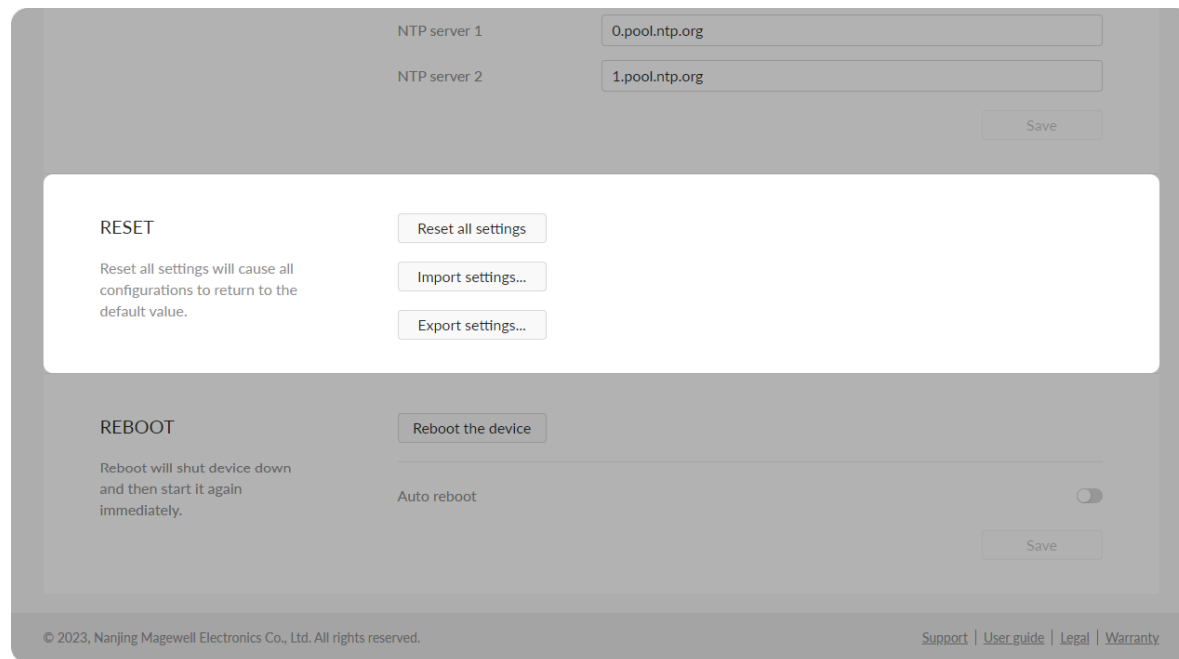

Reset Your Device

- **Reset all settings:** be cautious that resetting your device would restore configurations to defaults.
 - You can **Reset all settings** on the "SIGN IN" page, when the device is connected to PC via USB NET.
- **Import settings...** Click the button and select the target JASON format configuration file in the pop-up window, after importing the settings successfully, the device will be reconnected and you need to log in to the Web UI again.
- **Export settings...** Click the button, set the file name in the pop-up window, click "Export" to download the JASON format configuration file to the default path of your browser. The default file name is Settings_YYYY_MM_DD_HH_MM_SS.json.

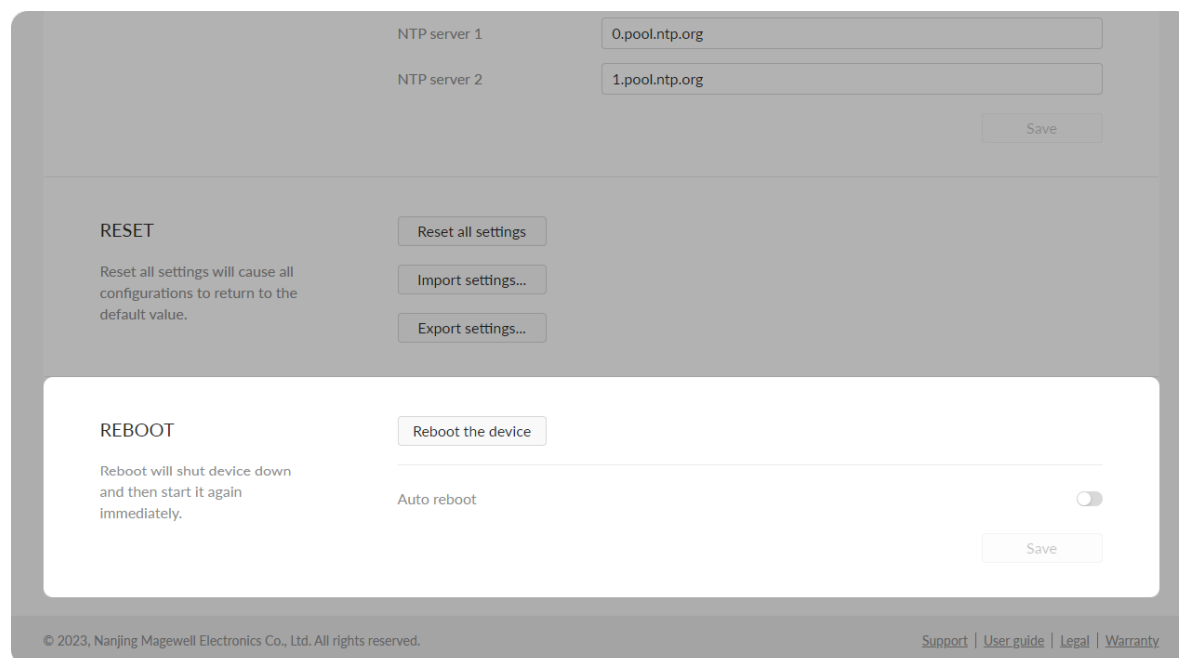

Reboot

- **Reboot the device:** power off the device and restart it when it does not work.
- **Auto reboot:** off by default. Turn it on to set Reboot time (YYYY-MM-DD HH-MM-SS), Reboot time, and click Save.
 - **Repeat event:** Support no-repeat (default), daily, weekly, monthly, yearly.
 - **Daily:** The repeat mode can be repeated every N days, or every workday.
 - **Weekly:** The repeat mode can be Repeat every 1 week next days:

multiple choices are available.

- **Monthly:** The repeating pattern may be repeat N days every N month, or on weekday every N month.
- **Yearly:** The repeating pattern can be every N day N month, or on N weekday of N month.

Network

Networking information, including Ethernet, USB NET, mobile network, Wi-Fi and AP, can be set in the **Network** tab.

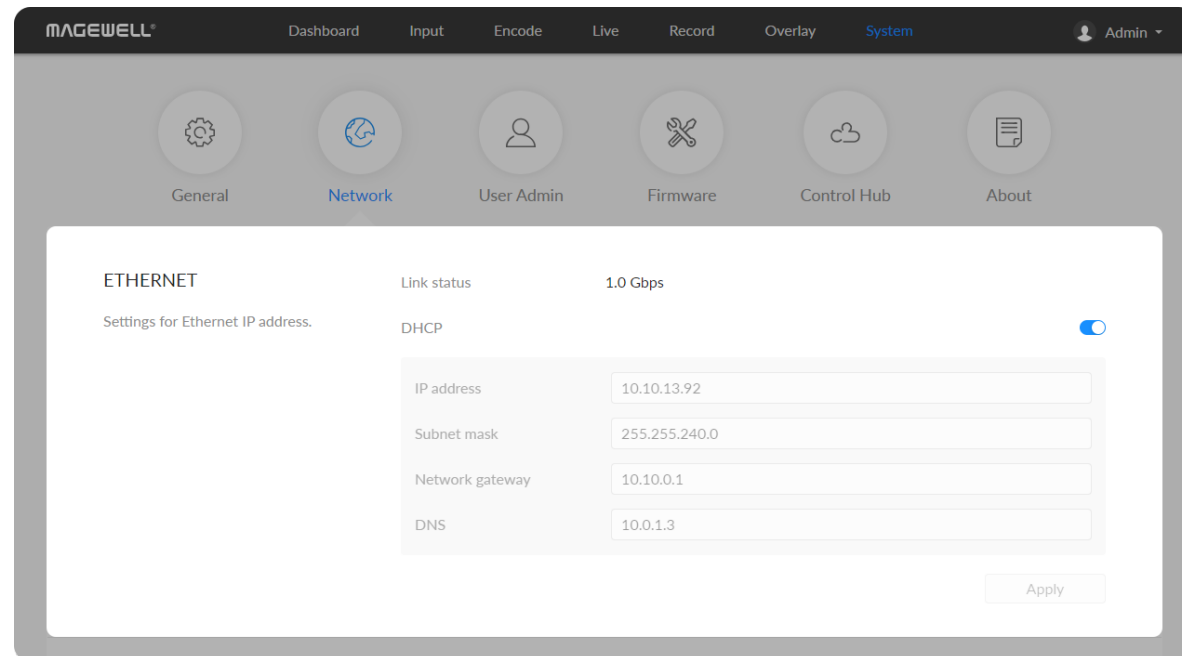

Set ETHERNET

The device automatically detects and connects to the Ethernet when networking to a DHCP-enabled LAN. Or you can set the IP address manually for a fixed IP address or an auto-networking failure.

- **DHCP:** it is on by default. Turn off the switch to modify current network setting or when being connected to a non-DHCP network.
 - **IP address:** device IP address.
 - **Subnet mask:** device subnet mask.
 - **Network gateway:** device gateway.
 - **DNS:** DNS server IP address.
- **Apply:** make current configuration effective. When prompted, click **Yes**.
- **Verification:** input new IP address to open the Web UI.

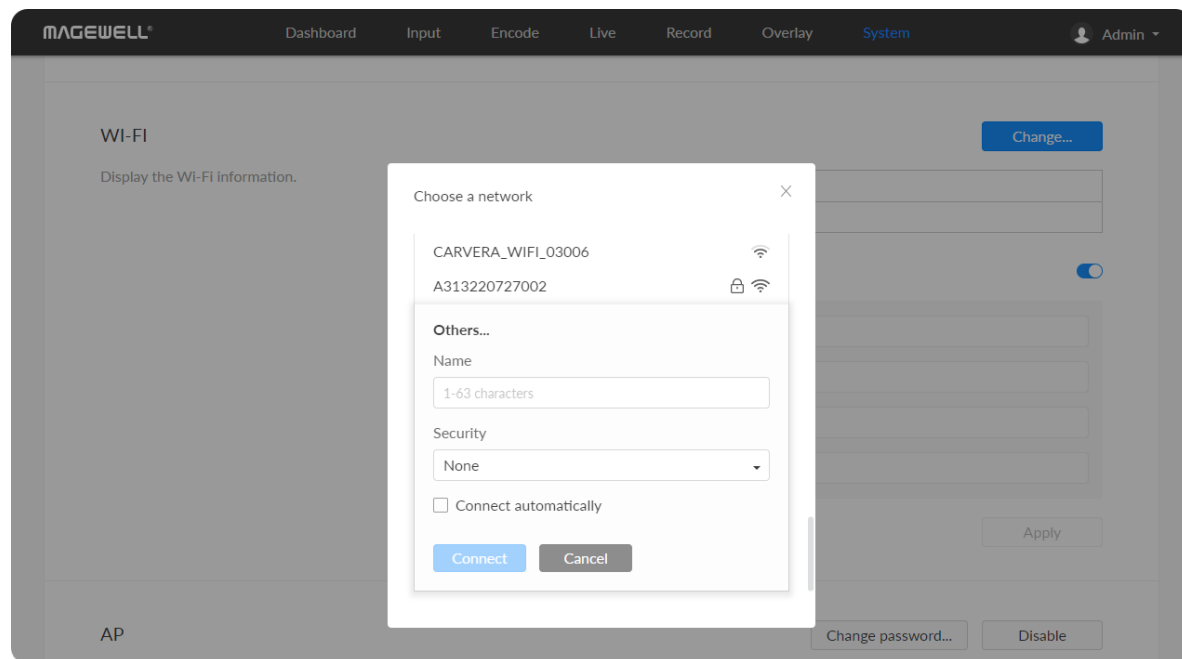
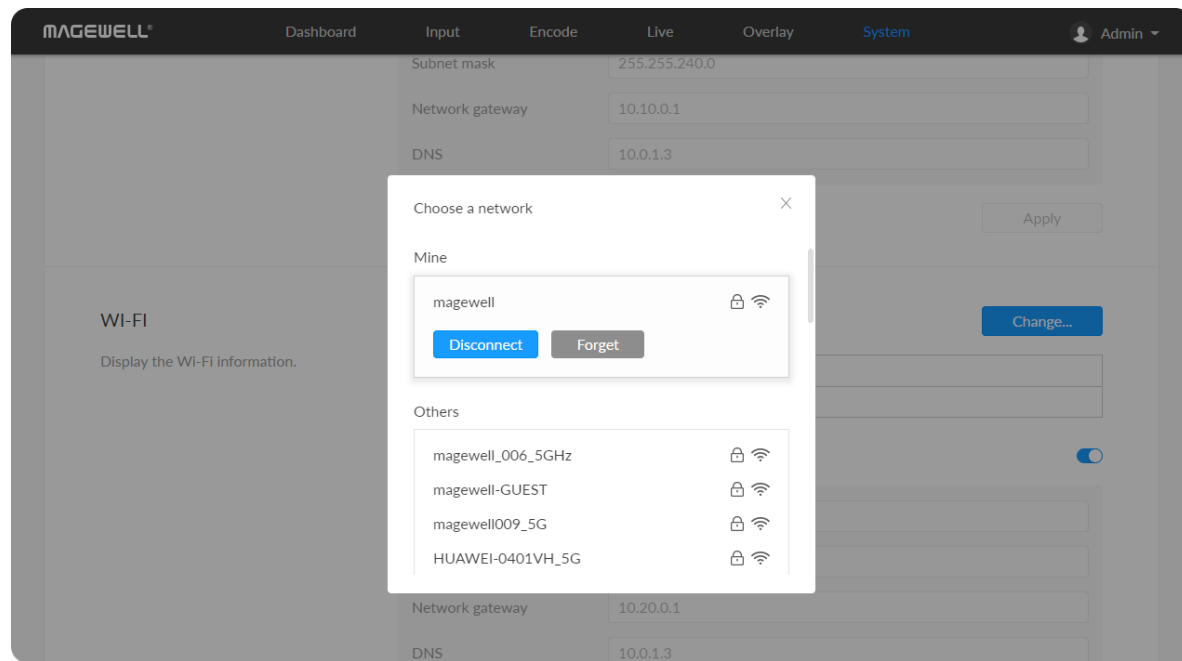

Set Wi-Fi

16 Wi-Fi network information can be saved for auto-detection.

- **Disconnect:** click to cut off current Wi-Fi network.
- **Change...** click to choose a different WLAN to connect to.
- **SSID:** named after device serial number.
- **Status:** Wi-Fi signal strength.
- **IP address:** WLAN IP address.
- **Subnet mask:** WLAN subnet mask.
- **Network gateway:** WLAN gateway.
- **DNS:** WLAN DNS server IP address.

Search Wi-Fi Network manually

1. Click **Change...** to choose a different WLAN to connect to, and **Enter the network security key**. If you select **Others...**, enter **Name** (1-63 characters) and choose a **Security** policy from **None**, **WEP**, **WPA**, and **WPA2/WPA3**, and enter the **Password** (8 characters at least).
2. (Optional) Check **Connect automatically**, then the Wi-Fi network will be joined automatically.
3. Click **connect**.

Set Wi-Fi manually

- **DHCP:** turn OFF the switch to modify current network setting or when being connected to a non-DHCP network.
- **IP address:** device IP address.
- **Subnet mask:** device subnet mask.

WI-FI Change...

Display the Wi-Fi information.

SSID	magewell
Status	Medium (-58 dBm)

DHCP

IP address	10.20.0.176
Subnet mask	255.255.255.0
Network gateway	10.20.0.1
DNS	10.0.1.3

Apply

AP Change password... Disable

Display the AP information.

SSID	B312220930005
------	---------------

AP Change password... Disable

Display the AP Information.

SSID	B312220930005
IP address	192.168.48.1
Subnet mask	255.255.255.0

USB NET Edit...

Settings for IP address of USB NET.

Link status	High Speed
IP address	192.168.66.1
Subnet mask	255.255.255.0

MOBILE NETWORK

Display the mobile broadband information.

IP address	192.168.8.161
Subnet mask	255.255.255.0
Network gateway	192.168.8.1
DNS	192.168.8.1

- **Network gateway:** device gateway.
- **DNS:** DNS server IP address.
- **Apply:** make current configuration effective. When prompted, click **Yes**.
- **Verification:** input new IP address to open the Web UI.

Set AP

You device can work as an AP to be joined to for remote web control.

- **SSID:** by default, it is named after the device serial number.
- **IP address:** fixed as 192.168.48.1.
- **Subnet mask:** fixed as 255.255.255.0.
- **Change password...**
 - **AP password:** the default AP password is the last 8-number of the serial number. For example, a serial number 313210101001 indicates the initial AP password is 10101001. It ranges from 8 to 16 characters including A-Z, a-z, 0-9, space, ., -, +, '[]() and cannot begin or end with a space.
- **Disable:** click to turn off AP mode. This renders you unable to manage the device over AP, which is not recommended, especially when you are using wireless network or linux/mac OS.

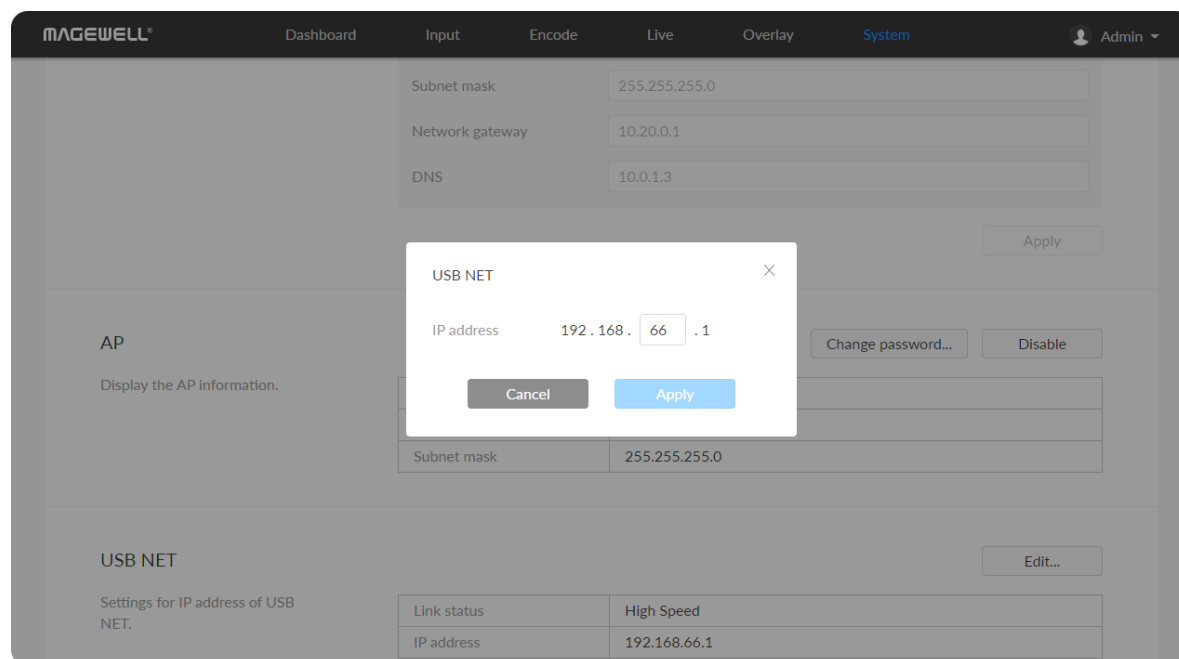
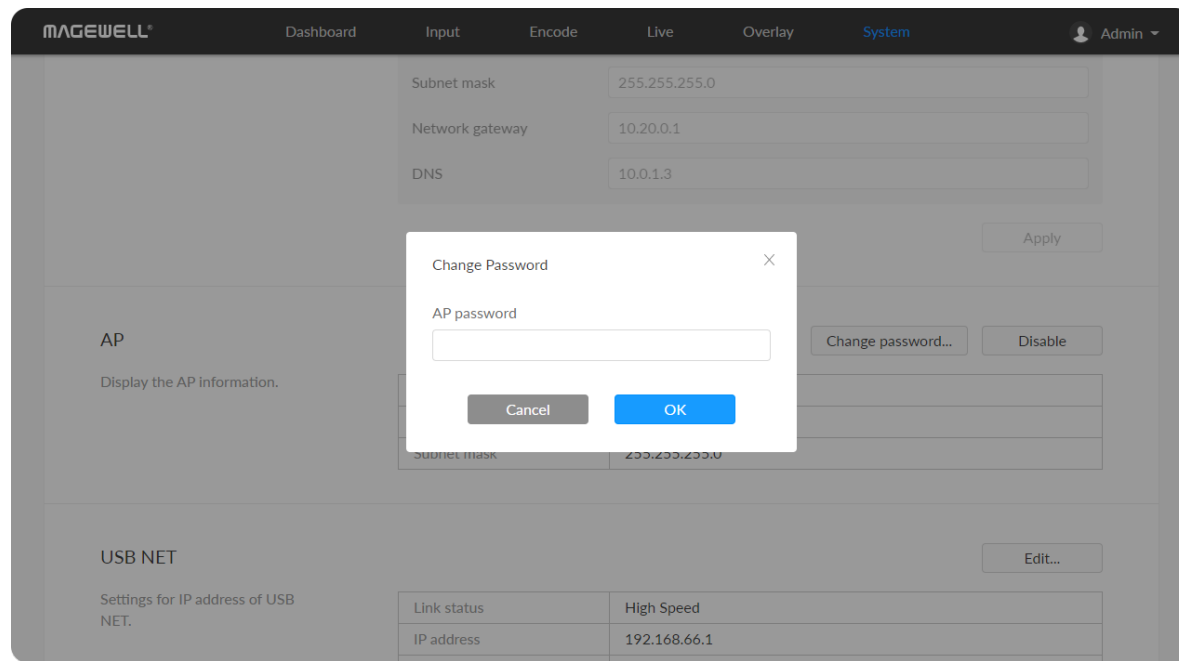

USB NET

You can connect your device to a PC via USB NET for remote control.

- **Link status:** USB NET connection status.
- **IP address:** USB NET IP address, 192.168.66.1 by default. You can click **Edit...** to change it.
- **Subnet mask:** Subnet mask of USB NET.
- **Edit...:** enter a new address and click **Apply** in the prompt window. The **IP address** will show the changed IP address after modification.

AP Change password... Disable

Display the AP information.

SSID	B312220930005
IP address	192.168.48.1
Subnet mask	255.255.255.0

USB NET Edit...

Settings for IP address of USB NET.

Link status	High Speed
IP address	192.168.66.1
Subnet mask	255.255.255.0

MOBILE NETWORK

Display the mobile broadband information.

IP address	192.168.8.161
Subnet mask	255.255.255.0
Network gateway	192.168.8.1
DNS	192.168.8.1

Set Mobile Network

The encoder supports streaming via a USB modem.

- **IP address:** IP address assigned by the USB modem.
- **Subnet mask:** subnet mask.
- **Network gateway:** gateway.
- **DNS:** DNS server IP address.

User Admin

Administrator right is required to perform the following tasks. The **User Admin** tab is invisible when you log in as a general user.

- [Create/Remove General User Accounts](#)
- [Modify User Password](#)

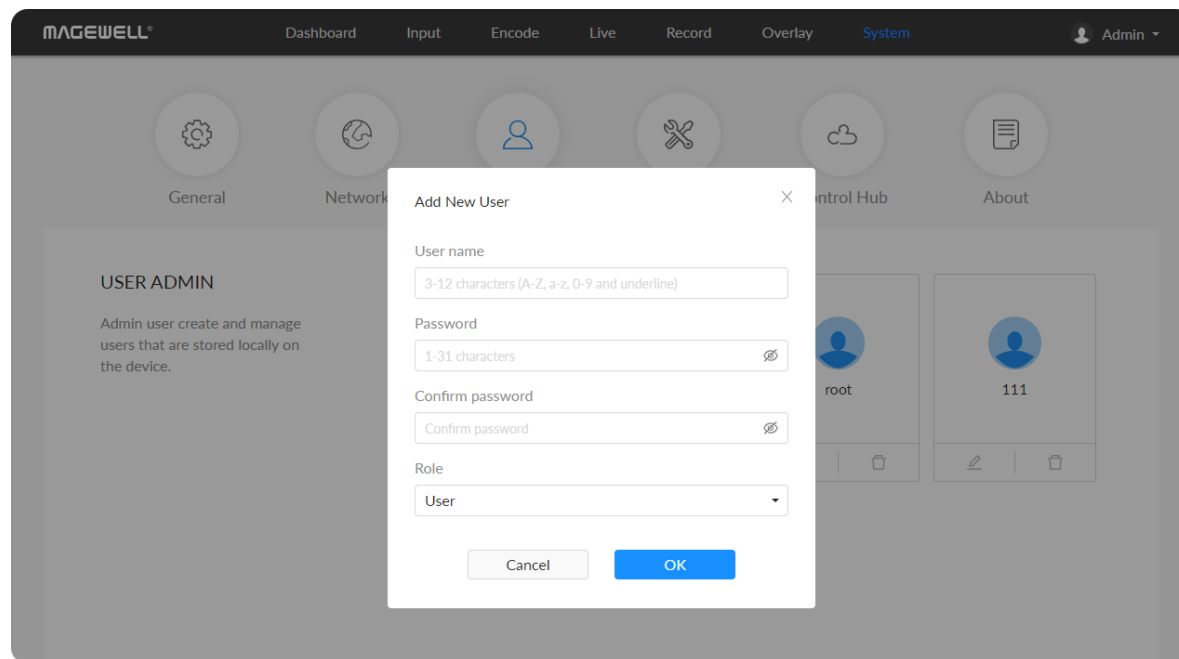

Create/Remove General User Accounts

After signing in with default admin account, you may need to add general users to give them permissions to do basic operations, like monitoring the device, or setting some of the parameters.

1. Access the Web UI, and sign in as administrator.
2. Go to **User Admin** tab.
3. Click **Add user**.
4. Enter username, password, and confirm your password.
 - The username is a string of 3 to 12 characters, which contains the letters A-Z, a-z, numbers 0-9 and underline.
 - The password is a string of 1 to 32 characters, which contains the letters A-Z, a-z, numbers 0-9 and special characters `_~!@#$%^&*-=.`
5. Assign the user to an Administrator role or a general User role.
 - Administrators have the highest level of access to an account.
 - A general user will have limited access to the account as per the permissions given by the Admin. You may not get access to the "User Admin" function.
 - The user role can not be changed. You might need to recreate a new

user.

6. Click **OK**.
7. Repeat step 3~5 to add multiple users. You can add up to 15 users.
8. To delete a user: Click **Delete** in the username card. When prompted, click **Yes**.

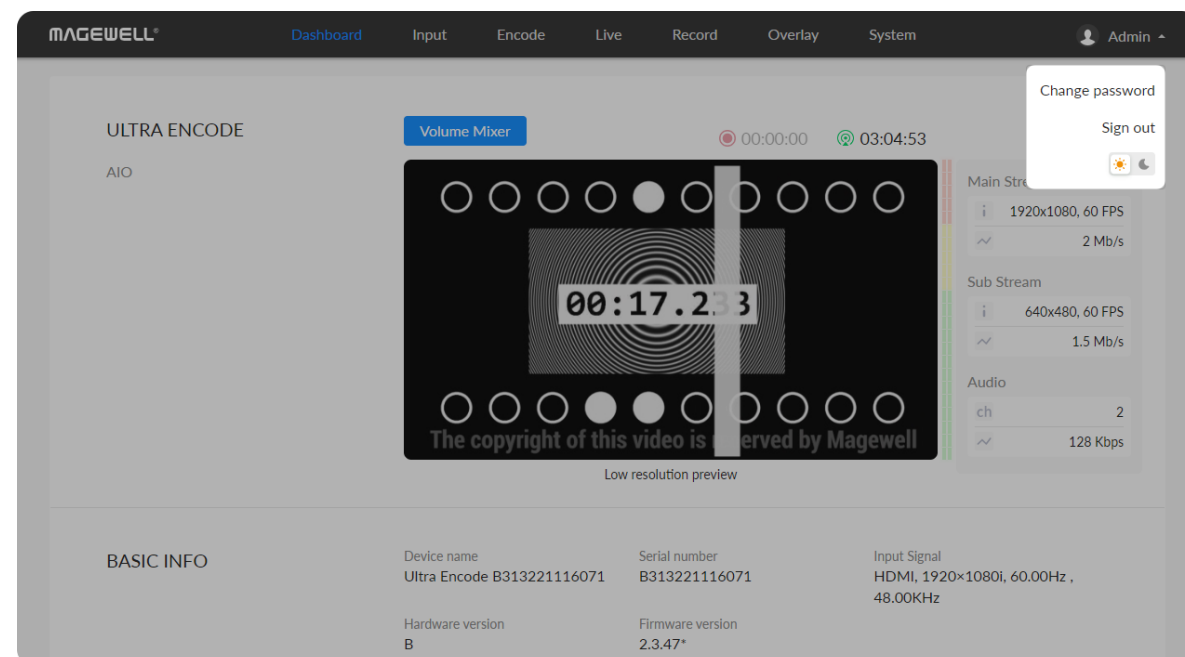

Modify User Password

Set Password in the following ways.

1. [Modify user password logged-in](#) via drop-list beside your avatar at the top right
2. [Modify a specified user password](#) in **User Admin** tab with admin account

Modify current logged-in user password

1. Log in Web UI.
2. Click the drop-list icon  beside your avatar icon, and click **Change password**.
3. In the pop up window, type in your old password, the new password, and confirm your new password.
The password is a string of 1 to 32 characters, which contains letters A-Z, a-z, numbers 0-9 and special characters `_~!@#$%^&*~+=.`
4. Click **OK**.

Change Password ✕

Old password

1-31 characters 🗑️

New password

1-31 characters 🗑️

Confirm password

Verify your new passcode 🗑️

Cancel OK

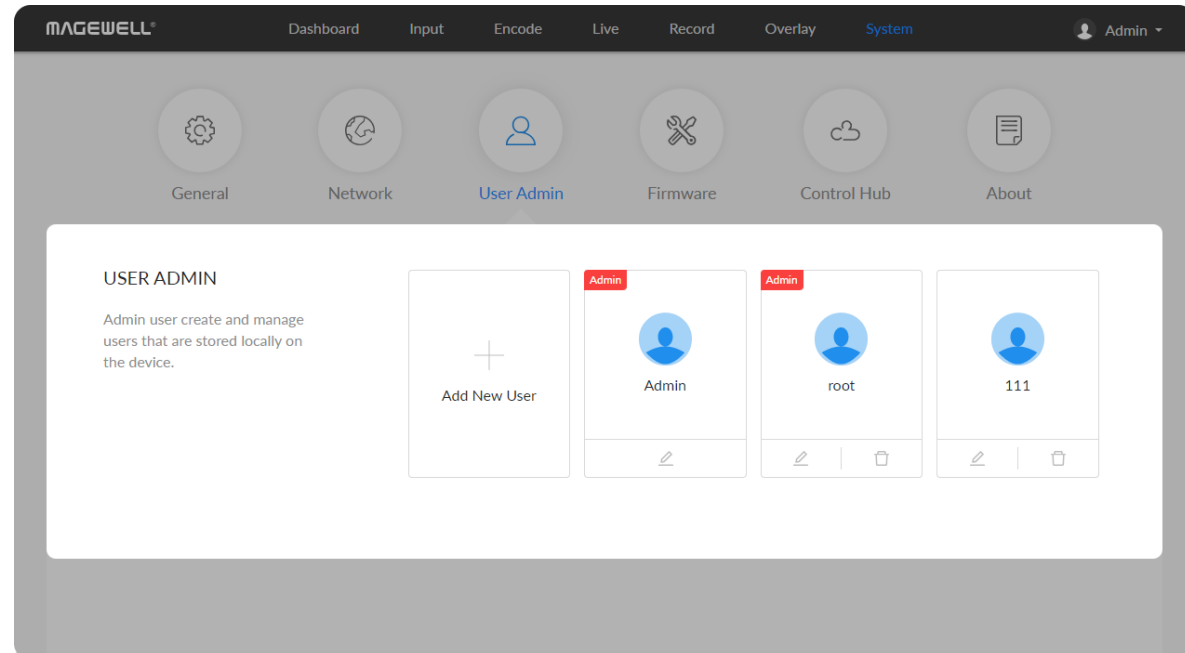

Modify a specified user password

1. Access the Web UI and sign in with the administrator account.
2. Go to **User Admin** tab, then you can change any user's password.
3. Click the  **Set password**.
4. In the pop up window, type in and confirm your new password.
The password is a string of 1 to 32 characters, which contains letters A-Z, a-z, numbers 0-9 and special characters `_~!@#$%^&*~+=.`
5. Click **OK**.

Set Password ✕

New password

1-32 characters (A-Z, a-z, 0-9 and _~!@#\$%^&*+=) 

Confirm password

Verify your new passcode 

Cancel

OK

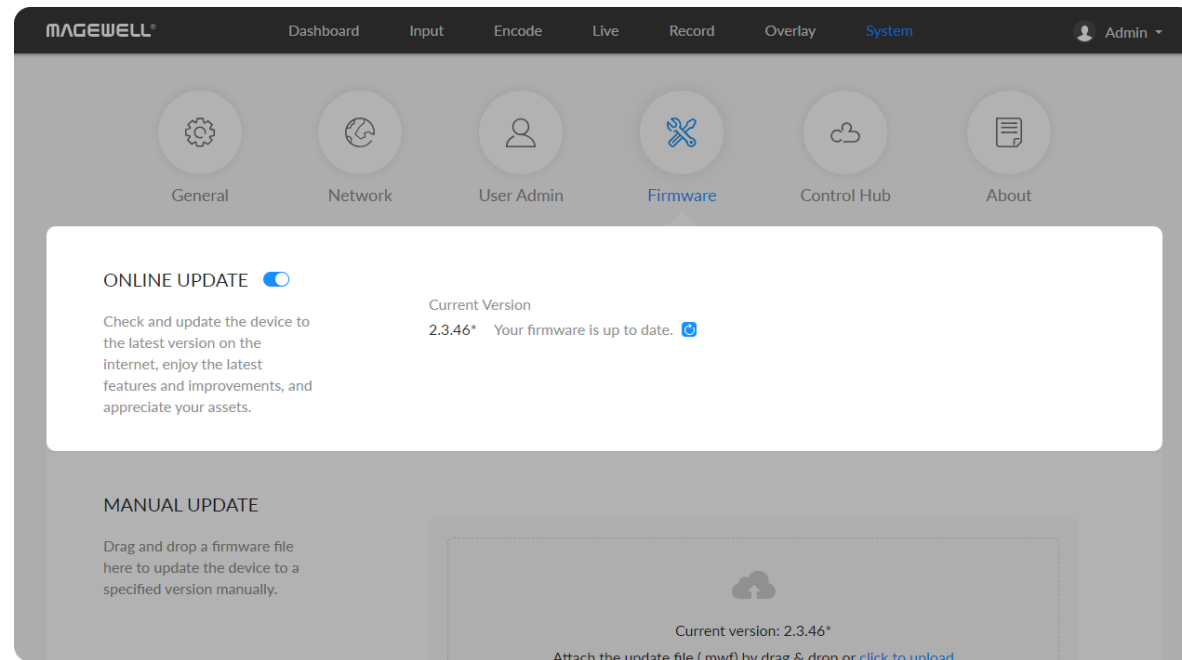

Firmware

Detect and update firmware to the latest version online, or you can manually add a firmware file to update the unit to specified version.



Online Update

By default, the function is on. When a new version is detected, a **Firmware** icon will flow on the control pane.

1. Turn on switch, and the online update function is on. The unit would detect the latest released firmware automatically when connecting to the Ethernet.
2. Click  icon to check for the latest firmware manually.
3. Click **Update** button to download and install the new version file if any. Do not disconnect from the power source or perform any operation while updating the firmware as this could damage your gear. After a successful update, the device will restart automatically.
4. Verification: click  checking for updates again.

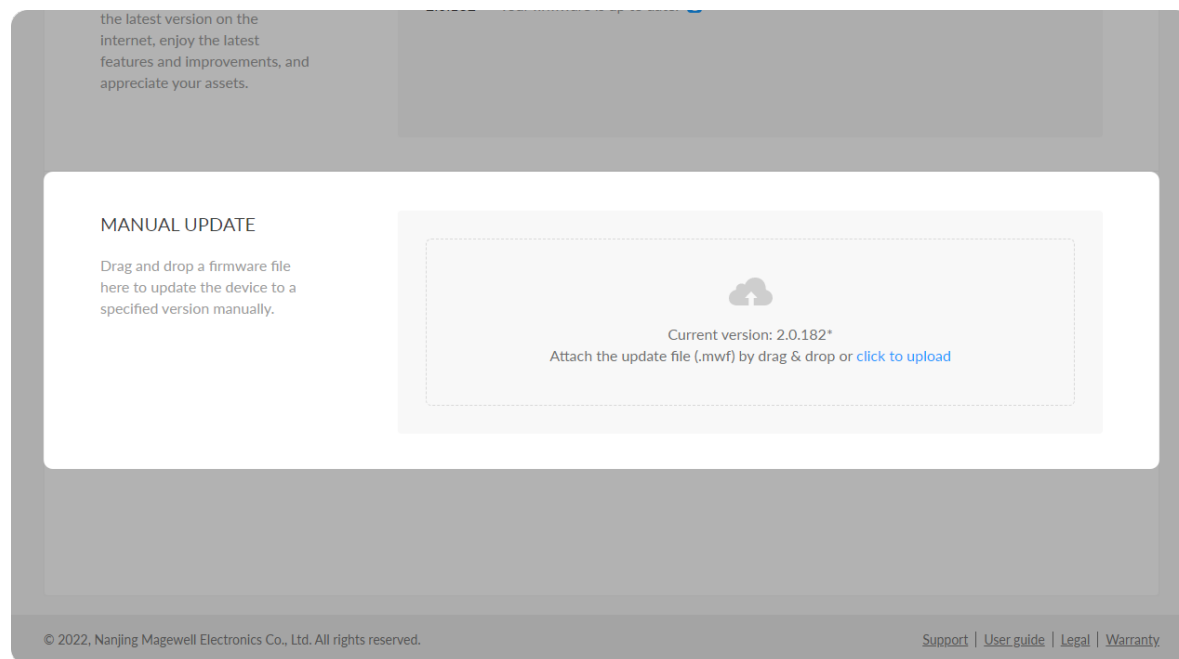

Manual Update

1. Click on **click to update** to select the **.mwf** firmware update file from your SD card, or just drag and drop the file from your computer into the upload zone.
Download firmware file from [our official website](#).
The device will automatically verify the update file and upload the file after the file verification is passed.
2. Click **Update** to download and install the new version file. Then the device will reboot to complete the update.
Do not disconnect from the power source or perform any operation while updating the firmware as this could damage your gear.
3. Verification: check the **Firmware version** in **Dashboard** or **Firmware** tab. It should be the same as your target version number.

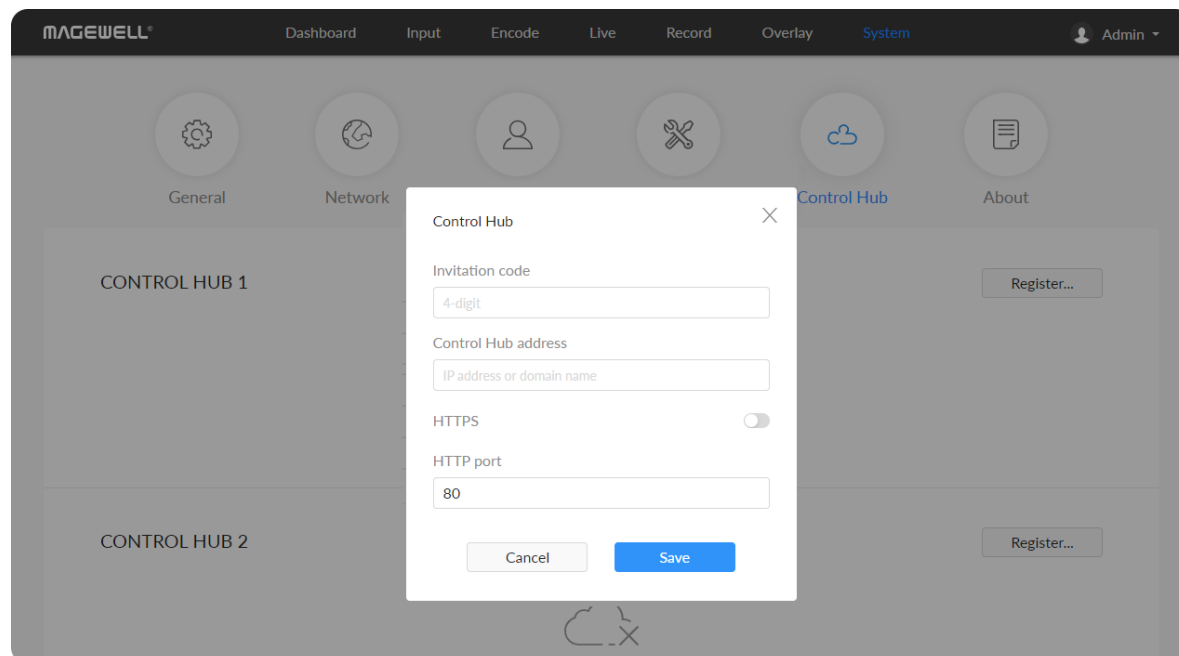

Control Hub

You can apply for remotely control using Control Hub. 2 cloud platforms are supported simultaneously, Control Hub 1 and Control Hub 2.

- Click **Register...** and input parameters in the prompted window. And save after configuration.
 - **Invitation code:** a 4-digital numbers security code obtained from Control Hub. If not leave it empty.
 - **Control Hub address:** input IP address or domain name of Control Hub.
 - **HTTPS:** Control Hub supports HTTPS access, you can enable it to set the HTTPS port number.

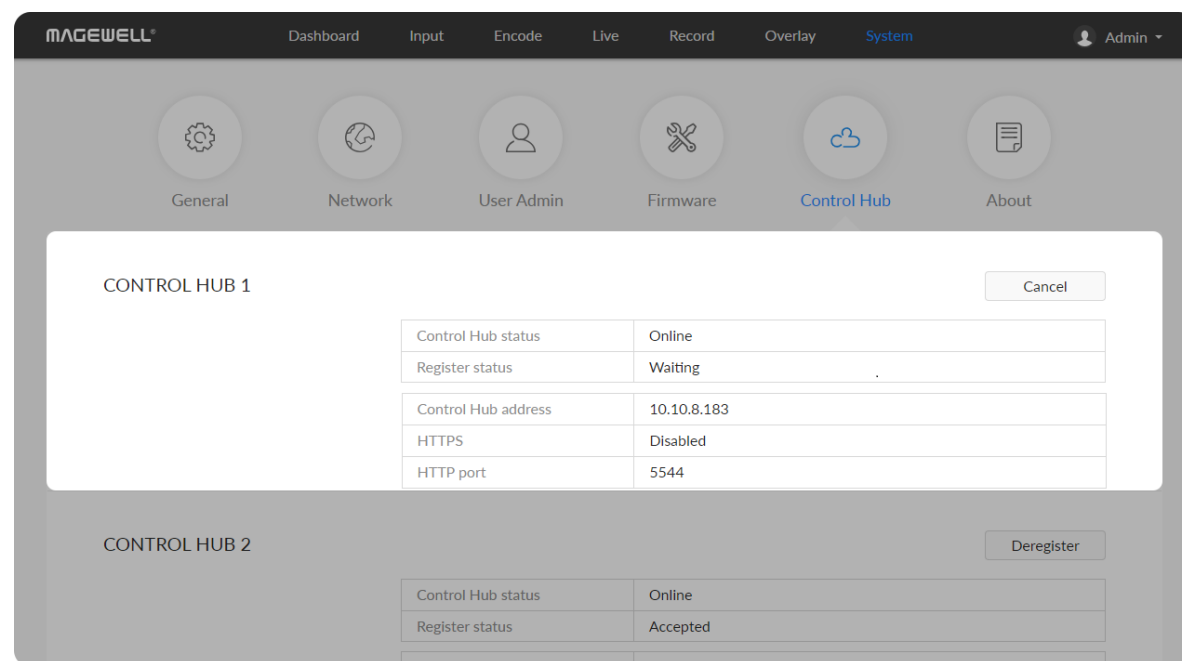

- **HTTPS port:** enter HTTP port number, which should be consist with that of Control Hub. 443 is the default port, and the port number ranges from 1 to 65535.
- **HTTP port:** enter HTTP port number, which should be consist with that of Control Hub. 80 is the default port, and the port number ranges from 1 to 65535.
- Click **Deregister** to stop the remote control from Control Hub.
- Check parameters related to Control Hub management.
 - **Control Hub status: Online or Offline.** Online indicates that the communication between device and Control Hub platform goes well. On the other hand, Offline indicates the communication is interrupted.
 - **Register status:** shows current status of cloud-join permission, including
 - Incorrect invitation code: you need to change your registration with correct code.
 - Waiting: registration is successfully submitted to Control Hub platform.
 - Approved: registration is approved. This device can be remotely controlled.
 - Rejected: Registration is denied.
 - Deleted: Registration is deleted, you can re-apply for joining the Control Hub.
 - **Control Hub address:** shows the IP address of Control Hub.
 - **HTTPS:** shows the enable status of HTTPS.

- **HTTPS/HTTP port:** shows the HTTPS/HTTP port of device used to communicate with Control Hub.

About

Obtain basic data for device maintenance in **About** tab.

The screenshot shows the MAGEWELL web interface. The navigation bar includes 'Dashboard', 'Input', 'Encode', 'Live', 'Record', 'Overlay', and 'System' tabs, with 'System' selected. A user profile 'Admin' is visible. Below the navigation bar are icons for 'General', 'Network', 'User Admin', 'Firmware', 'Control Hub', and 'About'. The 'About' tab is active, displaying a table of device information and a 'REPORT' section.

Device name	Ultra Encode B313221116072
Product name	Ultra Encode
Serial number	B313221116072
Hardware version	B
Firmware version	2.3.46*
Ethernet MAC address	D0:C8:57:81:49:7B
Wi-Fi MAC address	D0:C8:57:81:49:7C

REPORT
Take a snapshot of all current conditions of the device and export to a file for support.

Ultra Encode AIO
Generated at Tue Sep 12 05:42:31 2023

Check Device Information

- **Device name:** device name, which can be modified in the [System > General > Device name](#) area.
- **Product name:** device family name.
- **Serial number:** device serial number.
- **Hardware version:** device hardware version.
- **Firmware version:** device firmware version, which can be update in the [Firmware](#) tab.
- **Ethernet MAC address:** device Ethernet MAC address.
- **Wi-Fi MAC address:** device Wi-Fi MAC address.

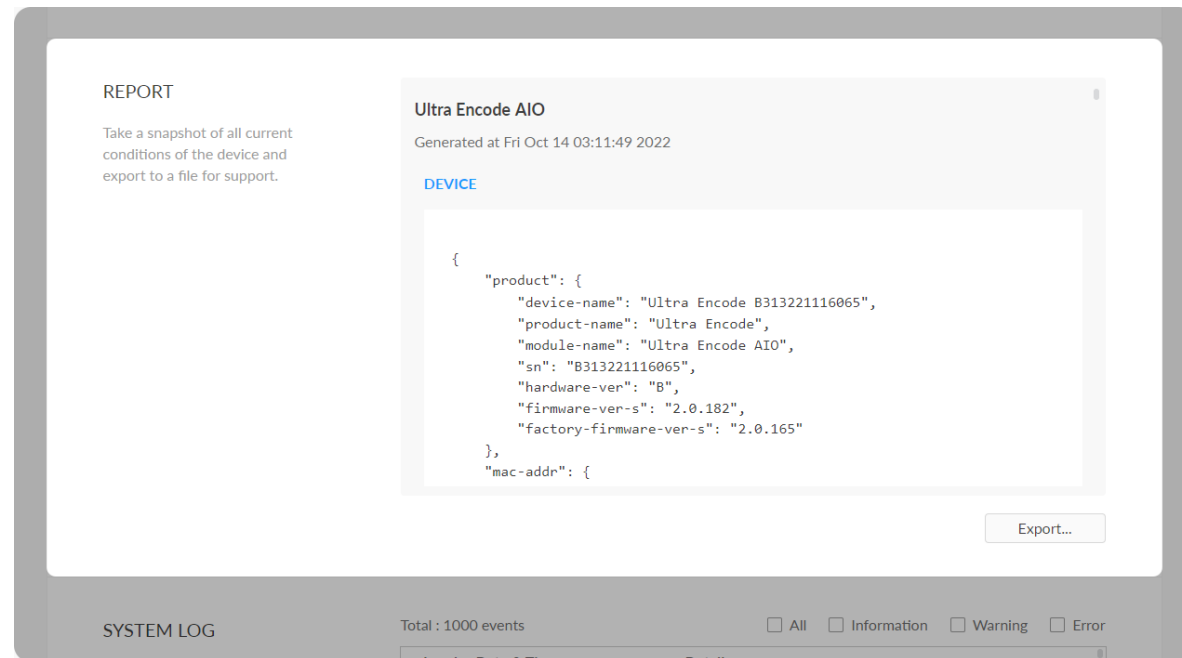

Export Reports

Export reports from your encoder when you want to get help from the Magewell Support team. These files will help our support engineers get a better understanding of your device status and other related information.

1. Go to **About > Report**.
2. Click **Export...** to generate a .html file.
3. When prompted, click **Export**.

SYSTEM LOG

Track important events generated by the device and export them as a file for technical support.

Total : 1000 events All Information Warning Error

Level	Date & Time	Detail
ⓘ	2022-10-14 03:05:48.152	Deleted user 'mmm'
ⓘ	2022-10-14 03:03:36.171	User 'Admin' (10.10.3.121) logged in, session: 1
ⓘ	2022-10-14 03:03:30.978	User 'Admin' (10.10.3.121) logged out
ⓘ	2022-10-14 02:55:54.487	User 'Admin' (10.10.3.121) logged in, session: 1
ⓘ	2022-10-14 02:40:04.261	User 'Admin' (10.10.11.125) logged in, session: 8
ⓘ	2022-10-14 02:39:54.397	Interface(eth0) IP valid and restarted server, name: SRT Caller, id: 2
ⓘ	2022-10-14 02:39:54.379	Interface(eth0) IP valid and restarted server, name: RTMP Server, id: 0
ⓘ	2022-10-14 02:39:54.216	Interface (eth0) was assigned IP address 10.10.9.153
ⓘ	2022-10-14 02:39:52.546	Audio signal present: 48000 Hz, 2 channels, 16 bits
ⓘ	2022-10-14 02:39:52.539	Video signal locked: 1920x1080i60.00
ⓘ	2022-10-14 02:39:52.530	Video signal locked: 1920x1080i60.00
ⓘ	2022-10-14 02:39:47.209	System startup
ⓘ	2022-10-14 02:30:24.791	Video signal locked: 1920x1080i60.00
ⓘ	2022-10-14 02:22:00.327	Video signal locked: 1920x1080i60.00
ⓘ	2022-10-14 02:21:45.815	Video signal locked: 1920x1080i60.00

Clear Export...

Clear/Export All Logs



1. Access the Web UI and sign in.
2. Click and enter the **System** tab, then select **Log**.
3. (Optional) Filter current logs.

By default, all logs are displayed in the table. Log entries can be categorized as "error", "warning", and "information".

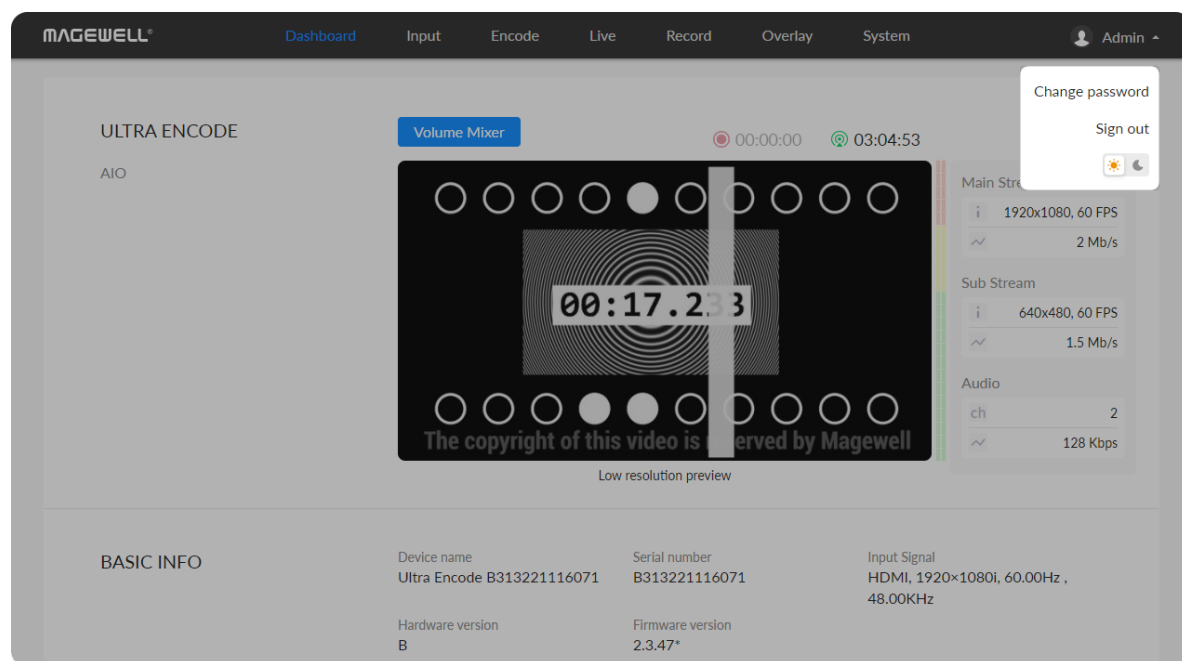
- **Total** shows the total number of filtered events.
 - **All**: Check to show all logs.
The device can store up to 1000 log entries. After 1000 entries have been recorded, the oldest entry will be deleted before a new one can be added.
 - **Information**: Check to show information logs - which record user actions or significant system events, e.g. login and signal locked.
 - **Warning**: Check to show warning logs - which mean something has not worked as it should. e.g. Ethernet is disconnected or signal is unlocked.
 - **Error**: Check to show error logs - which mean some serious error has happened.
4. (Optional) Click **Export...** to get a .html file of all logs.
When prompted in the window, click **Export**.
 5. (Optional) Click **Clear** to delete all logs.
When prompted in the window, click **Yes**.



Enable Dark Mode for Your WebGUI

1. Log in WebGUI.
2. Click the drop-list icon  beside your avatar icon, and click  to switch between day and night mode.

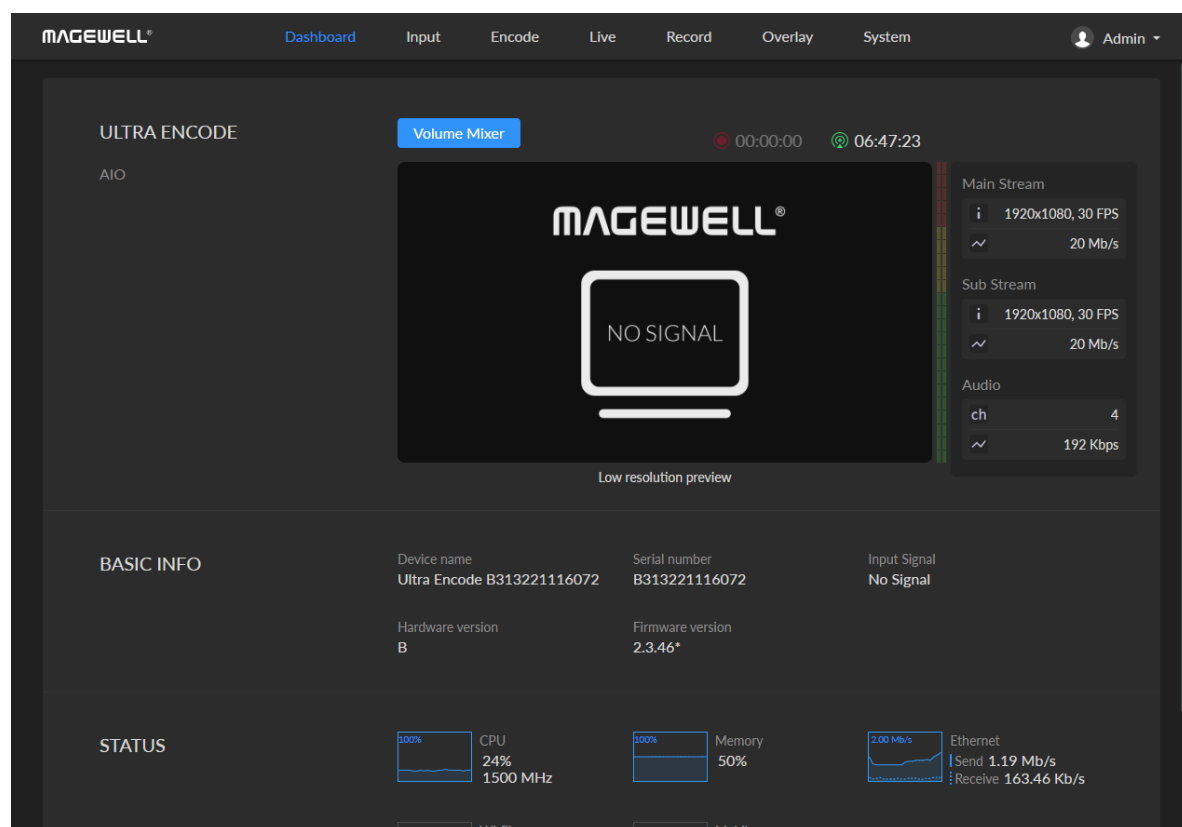

FAQ

How to turn on/off AP mode

AP mode is on by default. Administrator can go to **System > Network > AP** section to turn on/off the AP mode and change AP password.

Can I set one live stream server to use the main stream and the other to use the sub stream?

Yes. You can select the main stream or sub stream for each session.

Can Ultra Encode stream to multiple destinations at the same time?

- Supported streaming protocols: RTSP/RTMP/RTMPS/SRT Caller/SRT Listener/NDI[®]|HX2/NDI[®]|HX3/HLS/TS over UDP/TS over RTP/TVU ISSP
- Allow simultaneous 6 sessions over multiple streaming protocols, containing 1 session of HLS, RTSP, NDI[®]|HX2, or 2 NDI[®]|HX2 (if included)
- Specify main stream or sub stream for each streaming session
- Stream 1 NDI[®]|HX3 sessions, and they cannot stream simultaneously with other tasks

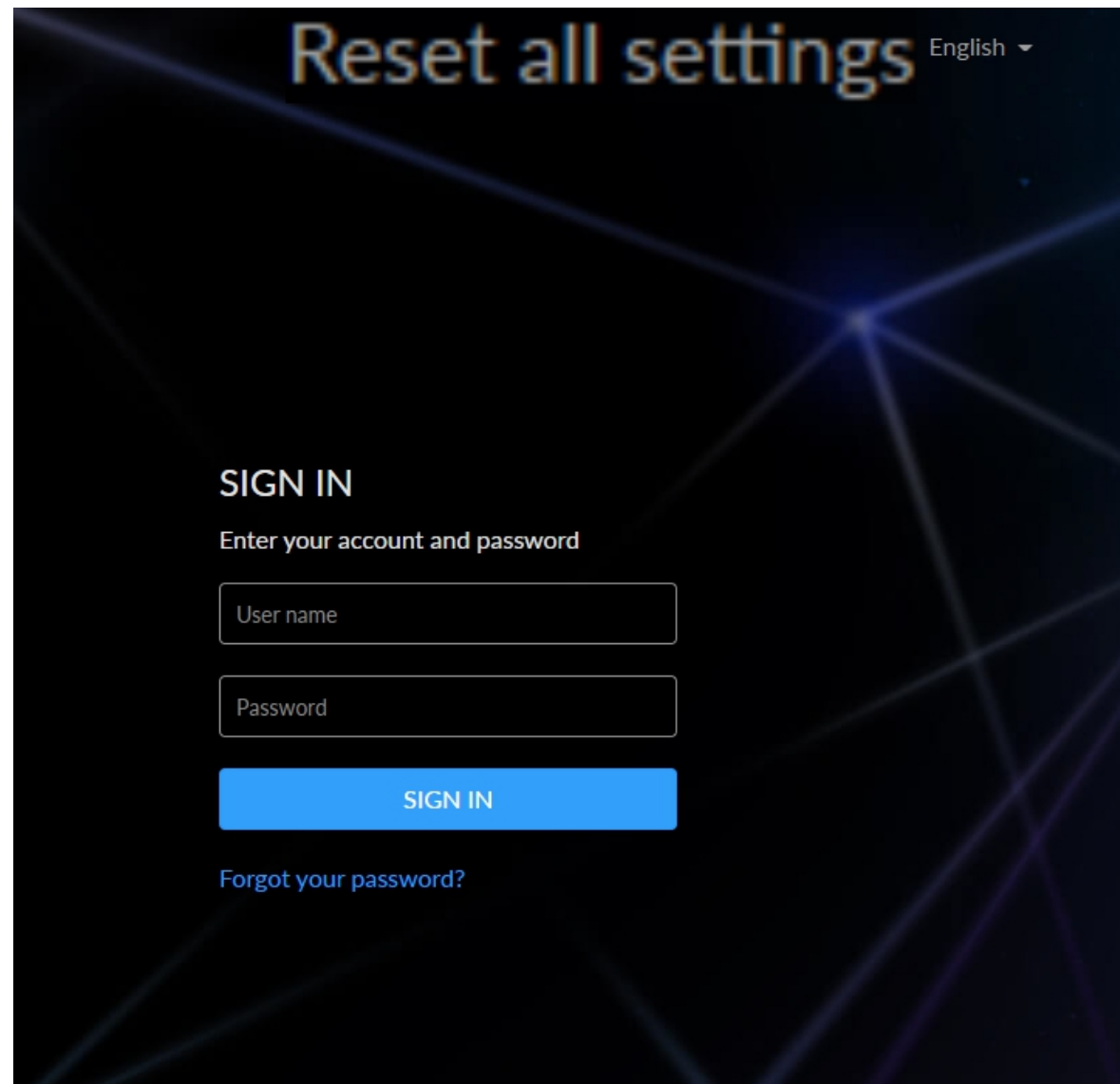
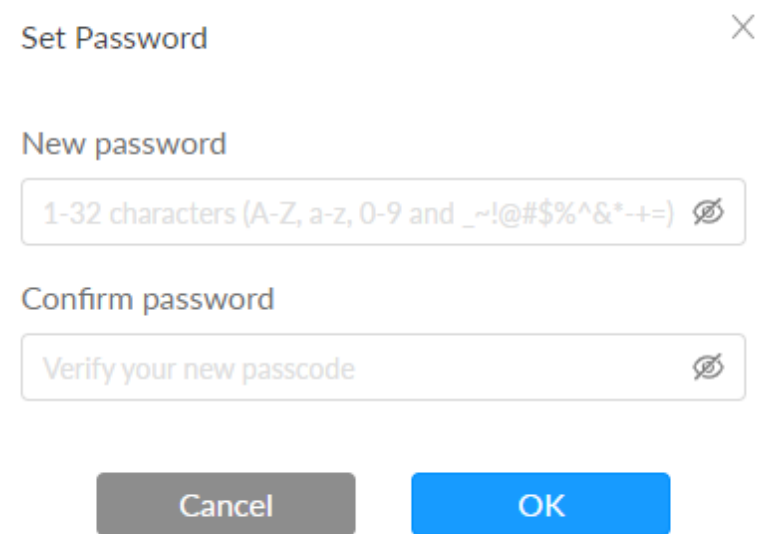

Fig1. Forgot admin password

What to do if I forget the Web UI password?

- Forgot admin password:
 1. Connect the device to your computer using USB cable.
 2. Type the USB NET IP address 192.168.66.1 in your web browser to access the Web UI.
- At top right of the "SIGN IN" page, click "Reset all settings" to restore all configurations to defaults, and the "Admin" password will be "Admin" again. Be cautious that resetting your device would restore configurations to defaults.



Set Password ×

New password

1-32 characters (A-Z, a-z, 0-9 and _~!@#\$%^&*+=) 👁

Confirm password

Verify your new passcode 👁

Cancel OK

Fig2. Forgot a general user's password

- Forgot a general user's password:
Sign in Web UI with the administrator account, go to **System > User Admin** tab, then you can change the specific user's password.

Support

Get the Latest Information

If you have any problems using Magewell products or need more technical information, please visit the following.

- Tutorial video: [Magewell TV](#)
- YouTube channel: [Magewell Video Capture Device](#)
- Knowledge base: [Ultra Encode Support](#)

Technical Support

Ticket System: If you have any questions using Magewell products or need technical assistance, please submit and track your inquiries by clicking [here](#).

Warranty

Limited Warranty

Except otherwise set between you and Magewell in advance in a written form, the free limited warranty service starts from the date on your proof of purchase. The proof can be: sales contract, formal sales receipt, invoice or delivery note. The earliest date of these proofs is the starting date of the free limited warranty.

The period of free limited warranty goes as below:

- Ultra Encode Family: two (2) years;
- The power adapter provided as accessories: one (1) year;

How to get the limited warranty

1. Please contact the Magewell support team by email (support@magewell.net) first, to determine whether your problem can only be solved by returning it to Magewell for repair. Magewell might ask you to take photos of the front and back of the defective products.
2. Magewell will issue an RMA letter to you if it is confirmed that you need to return the faulty product for further examination or repair. Please fill in the RMA with necessary information as required.
If it is regular repair, you will be responsible for the shipping cost, duties and insurance cost (if applicable); if the product is DOA, Magewell will be responsible for the shipping cost.
3. If some components need to be replaced, Magewell will decide to repair, renovate or replace the components by itself. Magewell may use new or repaired component to repair the product. The repaired product can be expected to work normally and the performance to remain the same. Repaired products can work in a good working condition and at least function the same as the original unit. The original replaced component will become the property of Magewell and components which are replaced for the client will become his/her property.
4. If the product is within warranty, Magewell will repair or replace the faulty units at its own discretion. In circumstances where the faulty unit is replaced by another one, Magewell may use new, repaired or renovated units. The faulty unit will then become the property of Magewell while the replacement unit will become the property of the purchaser.
5. If the warranty expires, Magewell will inform the purchaser whether the products can be repaired and the maintenance costs they need to pay. If purchasers

decide to repair, Magewell will repair, renovate, or replace the components after receiving the maintenance costs. If purchasers give up repairing, Magewell will dispose of the faulty unit if the purchaser chooses that option.

6. The repaired or replaced product assumes 1) the remaining term of the Warranty of the replaced unit or faulty unit; 2) ninety (90) days from the date of replacement or repair, whichever provides longer coverage for you. The extended warranty is only valid for repaired/replaced components.
7. The period of service depends on the client's location (country and area) and the product.

To view the complete warranty policy, please visit www.magewell.com/quality-assurance.

Notice

Copyright © 2024 [Nanjing Magewell Electronics Co., Ltd.](#)

All rights reserved. No part of this publication may be reproduced, distributed, or transmitted in any form or by any means, including photocopying, recording, or other electronic or mechanical methods, without the prior written permission of the publisher, except in the case of brief quotations embodied in critical reviews and certain other noncommercial uses permitted by copyright law.

Trademarks

HDMI, the HDMI logo and High-Definition Multimedia interface are trademarks or registered trademarks of HDMI Licensing LLC. Windows is trademark or registered trademark of Microsoft Corporation. OS X and macOS are trademarks or registered trademarks of Apple Inc. NDI is trademark or registered trademark of NewTek Inc. HEVC Advance is a registered trademark of Access Advance LLC. Other trademarks and company names mentioned are the properties of their respective owners.

About this Document

- This document is for reference only. Please refer to the actual product for more details.
- The user shall undertake any losses resulting from violation of guidance in the document.
- In case that PDF document cannot be opened, please upgrade the reading tool to the latest version or use other mainstream reading tools.
- This company reserves rights to revise any information in the document anytime; and the revised contents will be added to the new version without prior announcement. Some functions of the products may be slightly different before and after revision.
- The document may include technically inaccurate contents, inconsistencies with product functions and operations, or misprint. Final explanations of the company shall prevail.
- The only warranties for Magewell products and services are set forth in the express warranty statements accompanying such products and services. Nothing herein should be construed as constituting an additional warranty. Magewell shall not be liable for technical or editorial errors or omissions contained herein.